

# INSTRUCTIONS FOR Bin Rack, Single Sided, 12 Rails (#1431)

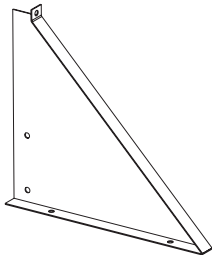

**PARTS:**



Right Hand Base  
**A x 1**

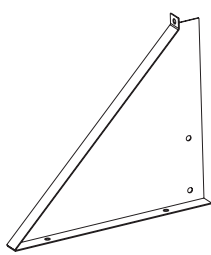

Left Hand Base  
**B x 1**

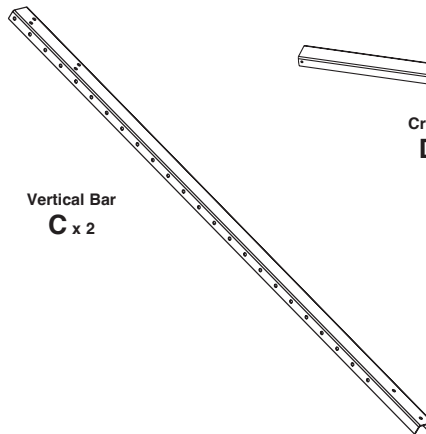

Vertical Bar  
**C x 2**



Cross Bar  
**D x 12**



1/4" - 20 Nut  
**H x 10**



Center Brace  
**E x 2**

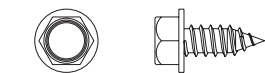

#14 x 5/8" Hex Head Sheet Metal Screw  
**F x 48**



1/4" - 20 x 3/4 Hex Head Bolt  
**G x 10**



1/4" Lock Washer  
**I x 10**

Call Free: 1.800.848.1633 • Fax Free: 1.800.447.2923  
GoHCL.com • hcl@GoHCL.com

# INSTRUCTIONS FOR Bin Rack, Single Sided, 12 Rails (#1431)

**TOOLS:**

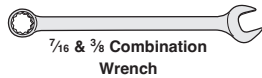
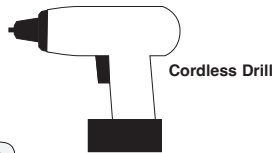
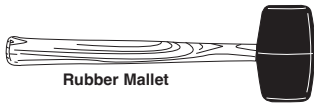

**1**

Attach a cross bar (D) to the lowest set of holes in each vertical bar (C) using four #14 sheet metal screws (F).

**IMPORTANT NOTE:** The open side of all of the cross bars faces up.

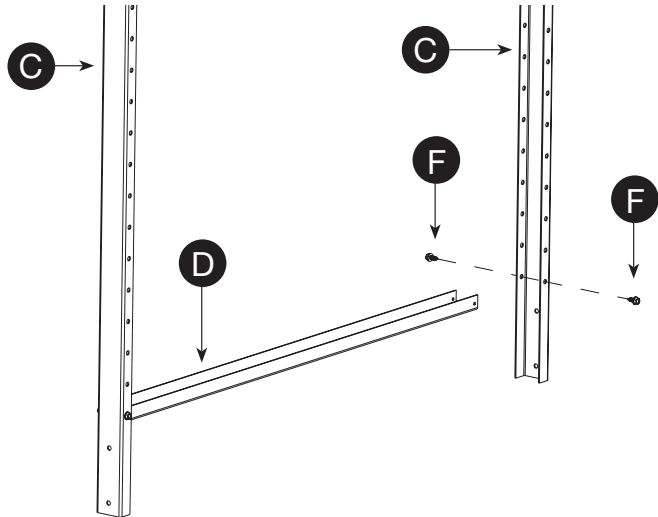

**2**

Install the right and left hand bases (A,B) using 1/4" bolts (G), washers (I) and (H) nuts. Bases attach in two places. Center braces (E) are attached to the vertical bar (C) and the cross bar (D) with 1/4" bolts (G), washers (I) and (H) nuts. The top of the bases will be attached in Step 3 with the installation of the remaining crossbars.

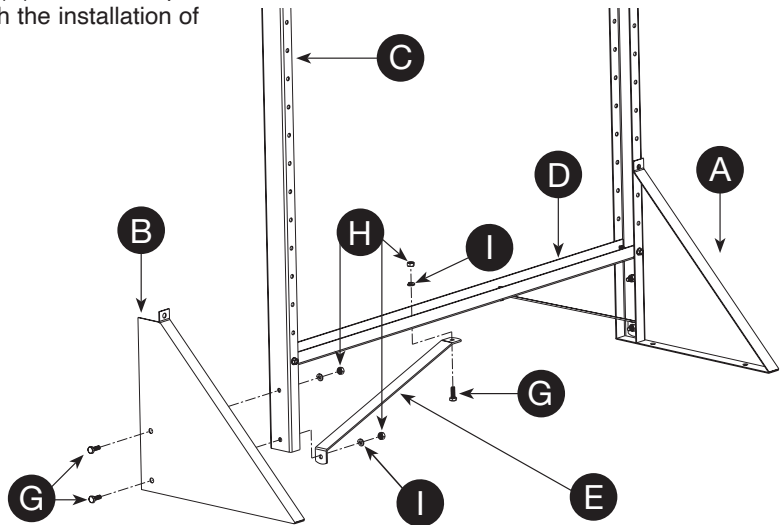

Call Free: 1.800.848.1633 • Fax Free: 1.800.447.2923

GoHCL.com • hcl@GoHCL.com

© Health Care Logistics, Inc. 2024

# INSTRUCTIONS FOR Bin Rack, Single Sided, 12 Rails (#1431)

## 3

**NOTICE:** For ease of assembly, first install hand-loose, then tighten all screws. The rubber mallet can be used to tap the cross bars into position.

Pattern: two cross bars; one empty hole. A cross bar (D) must be installed at the hole corresponding with the top of the base (B).

Attach cross bars (D) to the third and fourth holes from the bottom using #14 sheet metal screws (F). Skip every other hole and attach all remaining cross bars in pairs as shown. The last cross bar at the top is a single cross bar.

