

Health Care Logistics[®] INC.

Call: 1.800.848.1633

Web: GoHCL.com



Instruction Manual: HRX Pharmacy Scale

Models: HRX220, HRX220i, HRX320, HRX320i

Table of Contents

Table of Contents

Chapter 1: Cautionary Notes and Warnings 2

Chapter 2: Specifications 4

Chapter 3: Parts Description 5

Chapter 4: Keys and Display Indicators 7

Chapter 5: Unpacking the Scale and Getting Started 8

Chapter 6: Main Menu 10

Chapter 7: Pill Counting Setup 11

 7.1 Sample Size 11

 7.2 Advanced Pill Counting Accuracy..... 12

 7.3 Pill Fragment Detection..... 13

Chapter 8: Users 14

Chapter 9: Calibration 15

 9.1 Calibration – Automatic Internal..... 15

 9.2 Calibration - External..... 16

Chapter 10: Print 18

 10.1 Print Method 18

 10.2 Print Configuration..... 19

Chapter 11: Ports 20

 11.1 Baud Rate..... 21

 11.2 Bits..... 21

 11.3 Parity..... 21

 11.4 Installing Drivers..... 22

 11.5 Data Transmission and Exchange Protocol..... 24

Chapter 12: Date and Time..... 26

Chapter 13: Sound 28

Chapter 14: Firmware 29

Chapter 15: Restoring Default Settings 30

Chapter 16: Weighing 31

 16.1 Zeroing the Scale 31

 16.2 Taring the Scale..... 32

 16.3 Clearing the Tare..... 33

Chapter 17: Pill Counting 34

Chapter 18: Advanced Pill Counting Accuracy (APA) 36

Chapter 19: Pill Fragment Detection (PFD) 37

Chapter 20: Compounding 38

Chapter 21: Sealing the Calibration Switch..... 41

Chapter 22: Maintenance..... 42

Chapter 23: Accessories 43

Chapter 24: Replacement Parts..... 43

Chapter 25: Limited Warranty 44

Chapter 1: Cautionary Notes and Warnings

Important handling Cautions and Warnings

Always handle your scale with care.

Damage caused by improper handling is not covered under the scale's warranty.



Never drop or throw any articles onto the scale's pan or onto any other parts of the unit!



DO NOT let the scale fall or drop from its tabletop surface!

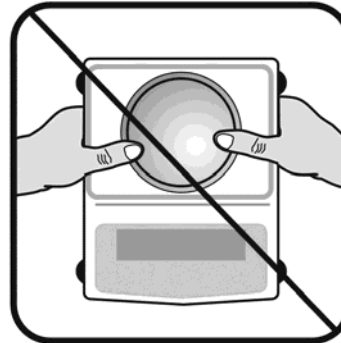

When moving the scale do not press or apply force onto the scales pan!



DO NOT pass or handle liquids directly over the scale to avoid spillage and liquid damage!

CAUTIONARY NOTES AND PRECAUTIONS

Always handle your scale with care. The correct location and proper environment makes an important contribution to the accuracy of the weighing results of TORBAL precision scales.

The optimum location for your scale:

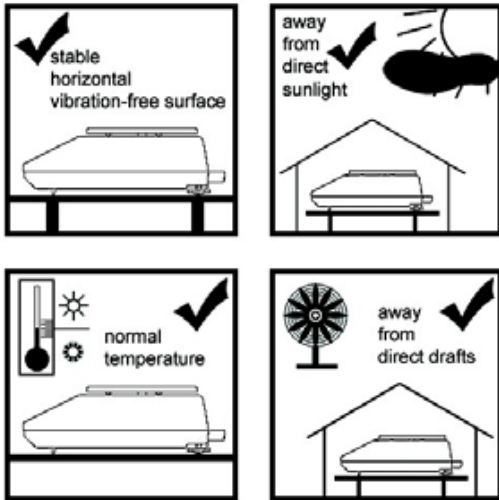

- Stable, vibration-free base as horizontal as possible
- Away from direct sunlight
- Not exposed to high temperature variations
- Away from direct drafts
- The best location is on a stable bench away from direct drafts, doors, windows, radiators and air conditioner vents.

CAUTION:



- The scale is designed for indoor use only.
- Do not operate the scale in hazardous areas or under dangerous conditions.
- Do not use the scale in locations subject to high humidity or dust.
- Do not connect cables in ways other than those mentioned in this manual.
- Set the scale on a firm, stable, horizontal surface.
- Never stand on or lean on this product. Equipment may fall or collapse, causing breakage and possible injury.
- Before moving the product, unplug it and unplug all cables connected to it.
- When storing, transporting or returning the scale for service, always use the original packaging.

WARNING:



- Never attempt to repair, disassemble or modify the scale. Tampering with the scale may result in injury and cause greater damage to the equipment.
- Be sure to use the specified power source.
- Do not allow foreign matter to fall onto the scale.
- If water or other liquid spills onto the scale, unplug the power cord immediately and contact technical support.

Chapter 2: Specifications

	Model		
	HRX220/i	HRX320/i	HRX520i
Capacity	220 g	320 g	520 g
Readability (d)	0.001 g	0.001 g	0.001 g
Verification (e)	0.01 g	0.01 g	0.01 g
Repeatability (Standard Deviation)	0.001g	0.001g	0.001g
Linearity	+/- 0.002g	+/- 0.002g	+/- 0.002g
Tare Range	-220 g -320 g	-320 g	-520 g
Stabilization time (typical)	Approx. 3sec		
Automatic Internal Calibration Available	Optional	Optional	Yes
Accuracy Class	II		
NTEP Certified for Prescription use and Pill Counting	YES		
Pan Dimension	4.5 in (115mm)		
Draft Shield	Optional		
Scale Dimension	7.3W x 11.4L x 3.5H in (185 x 290 x 90 mm)		
Operating Temperature	+18C to +33C		
RS232 Port	Bidirectional – Standard		
USB Port	Type B		
WiFi Ethernet	TCP IP (Optional)		
Power Supply	Input: 120VAC 60Hz 15W Output: 12VDC 2.1A		
Display Type	LCD		
Display Size	3.75 in x 1 in (95.25 x 25.4 mm)		
Weighing Units	Grams		
Scale Net Weight	5.7 lbs. (2.6 kg)		
Application Modes	Pill Counting & Compounding		
Printing	Yes		
MW (Minimum Piece Weight)	30mg (3e)		
MSS (Minimum Sample Size)	10 pieces		
Sample Size Selection	10, 30, 60, 90, 100		
Warranty	One Year		

Chapter 3: Parts Description

<p>Front</p>	<p>Side</p>	<p>Rear</p>
<p>Pan</p>	<p>Pan Support</p>	<p>Draft Ring</p>
<p>AC Adapter</p>	<p>Leveling Feet</p>	<p>Bubble Level Indicator</p>
<p>AC Adapter Socket Service Switch Access RS232C Port USB Port (WiFi or Ethernet)</p>		

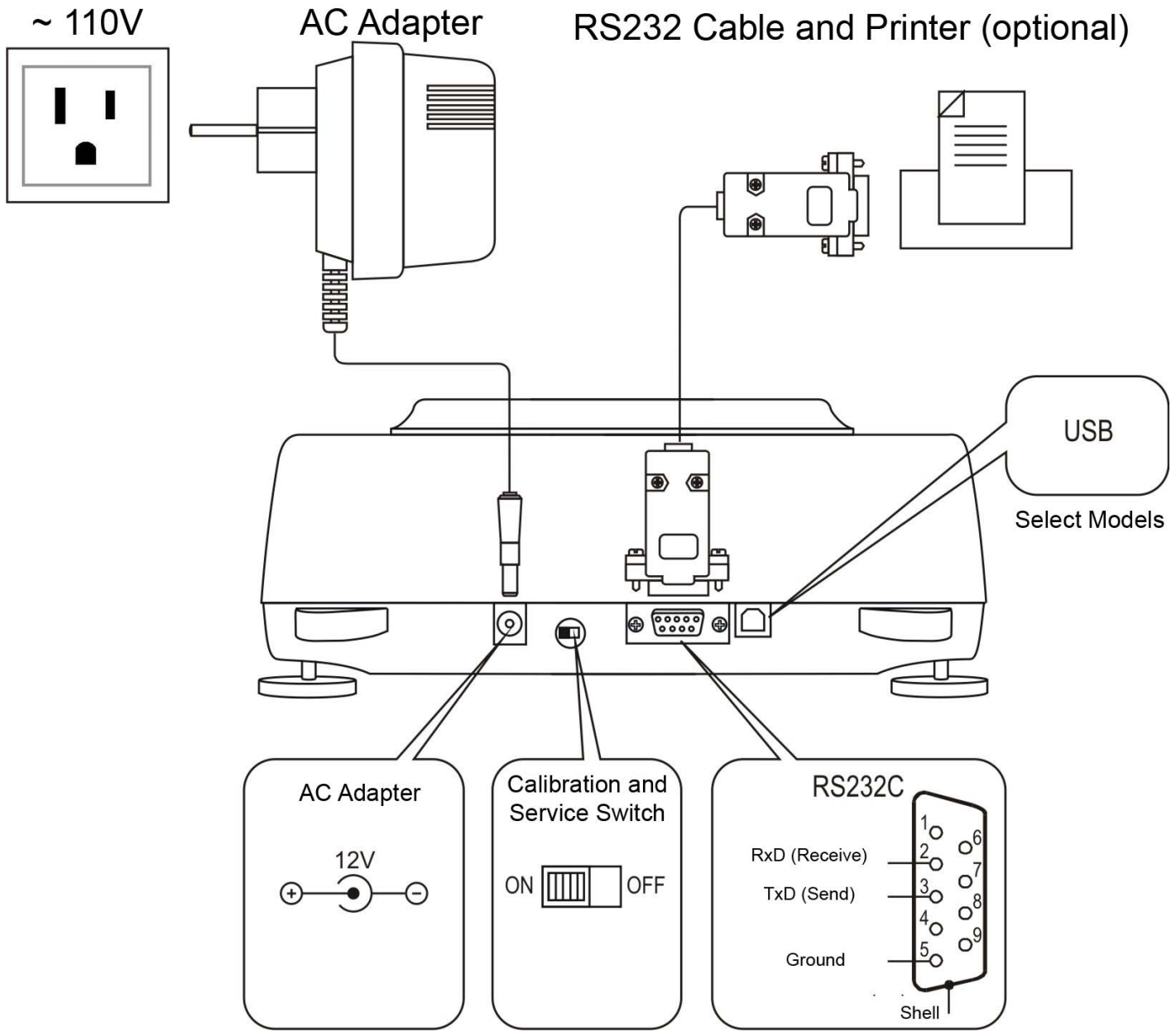

Chapter 4: Keys and Display Indicators

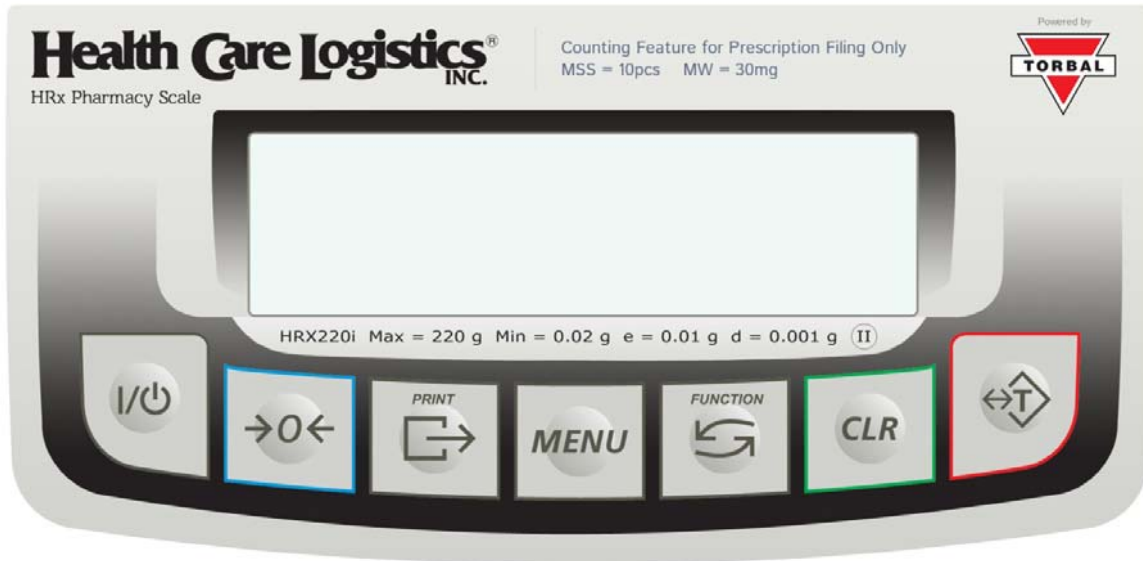

Key	Primary Function
I/O	Power On and Power Off
↔T	Tare – used to tare the weighing pan / Enter – Used to accept commands
→0←	Zero – used to zero the scale (Legal for Trade models only)
MENU	Menu – used to access the main menu
→	Data Transfer – used to print data or transfer data to a PC via the RS232/USB communication ports
Function	Toggle between weighing, counting, and compounding modes
CLR	Used to clear and cancel operations
Display Indicator	Description
▬	Stability Indicator - The weighing result has stabilized and an accurate reading may be taken.
→0←	Zero - The scale is maintaining a “center of zero” condition. (Legal for Trade models only)
MODE	Mode – The scale is in pill counting mode
NET	A tare was taken and the scale subtracted the tare weight from the gross weight to obtain the net weight.
AUT	AZSM - Auto-zeroing Setting Mechanism is enabled (Always enabled in Legal for Trade Scales)
A	APA – Advanced Pill Counting Accuracy is enabled (Flashes during APA stops in count)
F	PFD – A pill fragment has been detected
SUM	Displayed when multiple ingredients are compounded
TOTAL	The total weight of a compound is being displayed

Chapter 5: Unpacking the Scale and Getting Started

1. Carefully remove the scale, pan, and all of its components out of the packaging. Place them on a stable surface where the scale will not be affected by any mechanical vibrations or high air movements.
2. After removing the pan base and the pan from their packaging, carefully install the pan base (2) onto the scale by seating it on the pan support located in the middle of the scale. Once the pan base has been installed, carefully place the pan (1) on the base.
3. Once the pan has been installed, level the scale by adjusting the front feet (6) until the level indicator (7) shows the “air bubble” is in the center position of the sight glass. The level indicator is located on the rear left side of the scale.

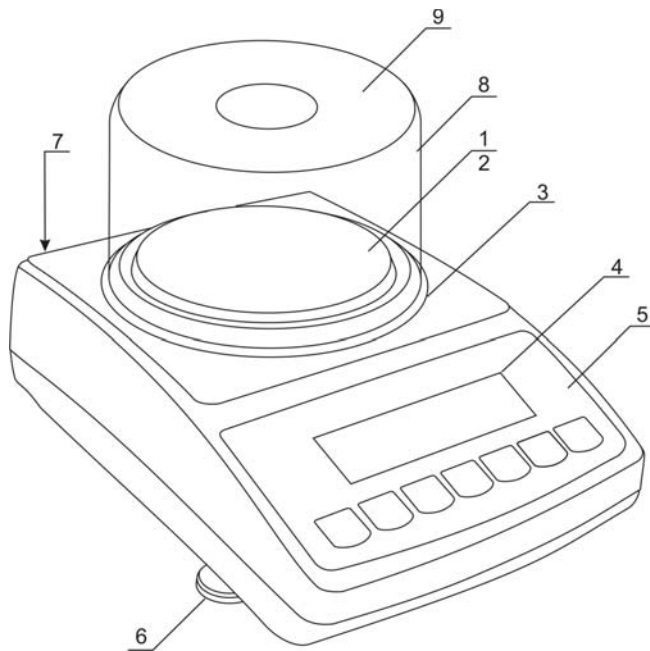

- 1 – pan
- 2 – pan support (under pan)
- 3 – draft ring
- 4 – display LCD
- 5 – keys
- 6 – rotating legs
- 7 – level indicator
- 8 – draft shield (option)
- 9 – draft shield cover (option)



Correct



Incorrect

- After leveling the scale, plug the AC adaptor to the AC adaptor socket located in the rear of the scale.

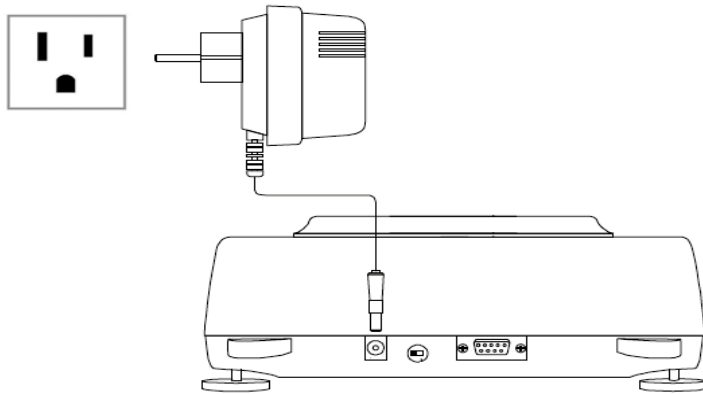

- When the AC adaptor is plugged into the wall outlet, the scale will automatically turn on, and go through its initialization process. If the scale is equipped with automatic internal calibration it will calibrate itself. The calibration process will initialize automatically whenever the scale is turned on. The scale will also calibrate whenever the temperature changes by 1 degree Celsius and at two-hour intervals. Calibration will initialize only if the scale has been stable and idle for 60 seconds, in order not to interrupt weighing operations. The scale will display “--CAL t” when calibrating.

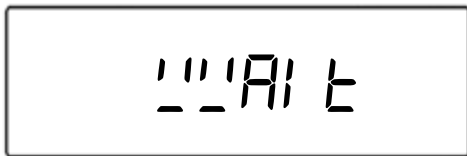

Note – Automatic Internal Calibration Models: When the AC adaptor is plugged into the wall outlet for the first time, the scale will automatically and frequently initialize temperature calibration as the internal parts of the scale heat up. The scale will display “--CAL t” when calibrating. Once the internal temperature stabilizes, the scale will calibrate whenever the temperature changes by 1 degree Celsius and at two-hour intervals.

Note: The scale will always start up in the mode that was enabled when it was turned off.

- To put the scale into standby mode, leave the AC adaptor plugged into both the scale and the wall outlet and press the Power “OFF” button. The “OFF” indicator will light up in the upper left corner of the display signaling the scale is in standby mode.

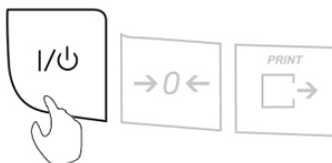

Chapter 6: Main Menu

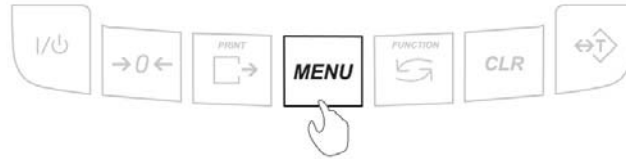

Pill Counting Setup (COUNT): Enable/Disable pill counting mode. Configure pill counting settings such as sample size, advanced pill counting accuracy, and pill fragment detection.

Advanced Pill Counting Accuracy (APA) – An algorithm designed to adjust for production LOT pill weight variations and provide greater accuracy when counting large quantities.

Pill Fragment Detection (PFD) – Feature used to detect pill fragments or broken pill during a count. When a fragment is detected, the user is notified so that pill can be removed.

Users (USER5): Assign up to five unique User ID numbers. The User IDs can be included in the transaction receipt when printing.

Calibration (CALIB): Manually begin automatic internal calibration. Print out calibration reports.

Print (PRINT): Configure format of the print receipt (i.e. date, time, and user ID).

Serial Ports (PORT5): Configure baud rates of the USB and RS232 ports.

Date/Time (DATE): Set the scale's time and date.

Sound (SOUND): Enable/Disable the scale buzzer.

Firmware (FIRMWARE): Updates the scale firmware via PC.

Default (DEFAULT): Reset the scale to default factory settings.

Chapter 7: Pill Counting Setup (Count)

To configure the pill counting feature select “Count” from the main menu and follow the steps below.

7.1 Sample Size (SAPL)

Before performing a transaction, the average piece weight (APW) of the drug being counted needs to be determined. The APW is calculated by taking the average weight of a sample of pills or tablets. The sample size determines the number of pill or tablets that will be used in the sample.

1. To configure the Sample Size, press the Menu key. Select “Count” by pressing the T key.

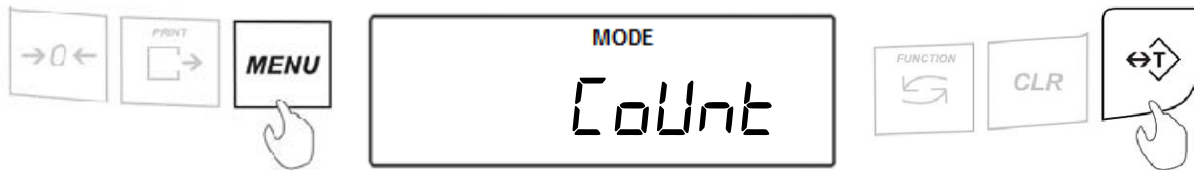

2. Select “SAPL” by pressing the T key.



3. Choose the sample size that will be used to establish an average piece weight (**Options are 10, 30, 60, 90, and 100**). To confirm the sample size press the T key.



7.2 Advanced Pill Counting Accuracy (APA)

APA is used to adjust for slight variations in pill weights on large counts. To activate APA, pause filling between select intervals during a count. The scale will recalculate the average piece weight during these breaks in the count. **(Intervals are 10-15, 20-30, and 50-70).** APA can be used by stopping at just the first two intervals or at all three. To use the APA feature follow the steps below.

1. To configure APA, press the Menu key. Select “Count” by pressing the T key.

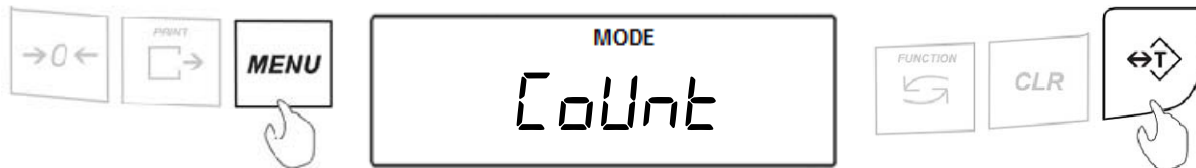

2. Select “APA” by pressing the T key.

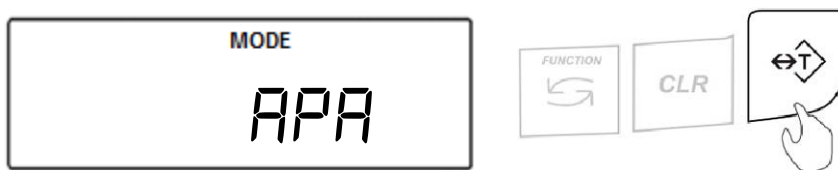

3. Enable APA by choosing either the “2 STOP” approach or the “3 STOP” approach. Confirm the selection by pressing the T key.

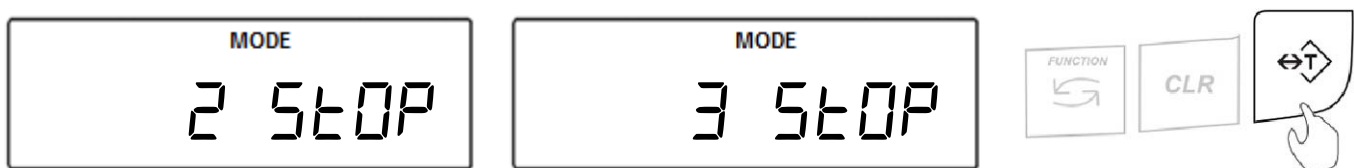

4. To disable APA select “OFF” by pressing the T key.

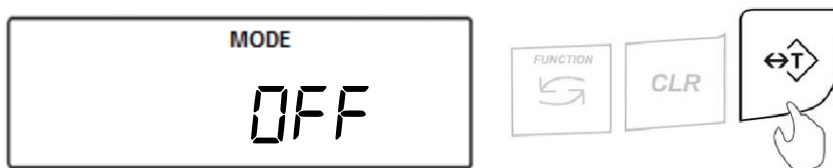

Note: If APA was not performed or activated at the 10 to 15 range, it will not activate in the 20-30 range.

7.3 Pill Fragment Detection (PFD)

Pill Fragment Detection (PFD) is used to spot pill fragments which have been accumulated in the weighing container during a count. Fragments are detected when a calculated percentage of an average pill weight is detected.

1. To configure Pill Fragment Detection, press the Menu key. Select “Count” by pressing the T key.

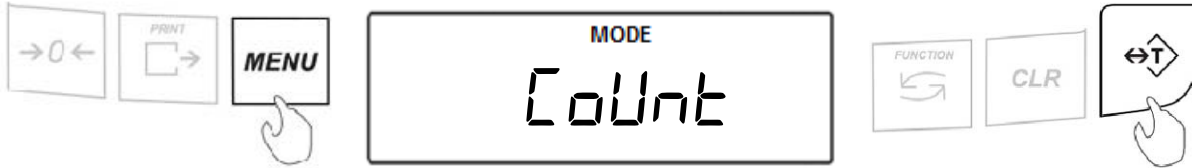

2. Select “PFD” by pressing the T key.



3. Enable PFD by selecting “On” or disable it by selecting “OFF”. Confirm the selection by pressing the T key.

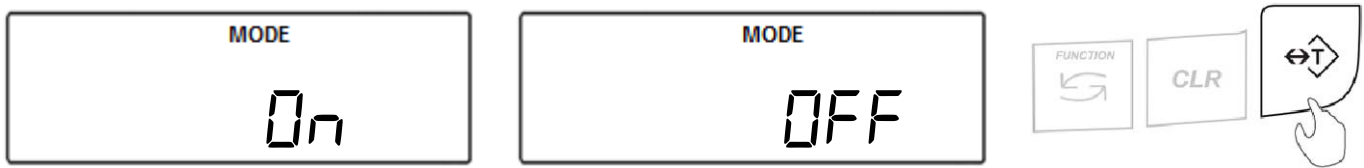

Chapter 8: Users (USER5)

The Users menu allows for 5 unique user IDs to be entered into the system.

1. To set the user IDs, press the Menu key. Select “USER5” by pressing the T key.

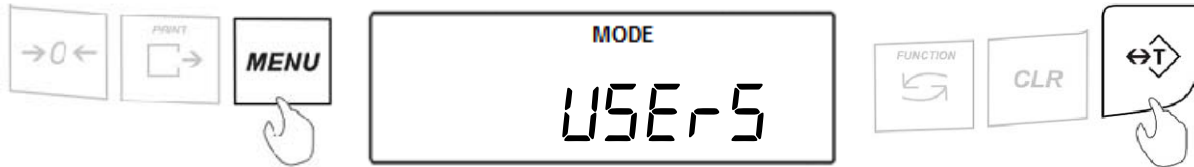

1. Choose an ID to edit (i.e. ID 1, ID 2...ID 5) by pressing the T key when it is displayed.

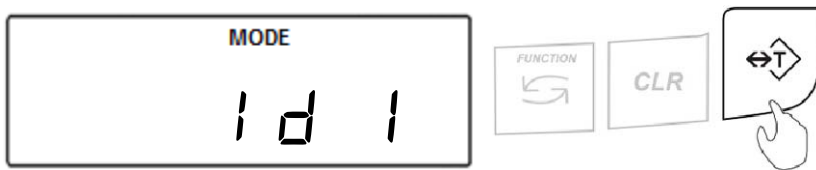

2. Press the T key to add a digit. Press the Function key to increment a digit.

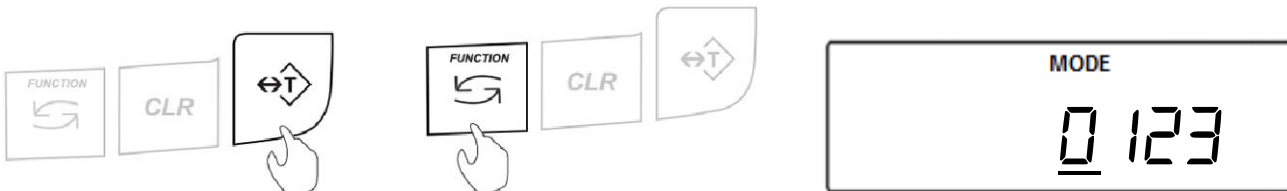

3. Press the Menu key to accept the ID number.

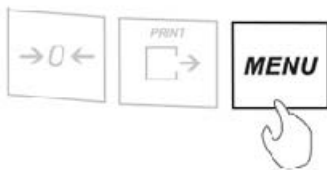

Chapter 9: Calibration

9.1 Calibration - Automatic Internal:

Automatic Internal Calibration Models: calibration is automatically performed every time the scale is turned ON or initialized. Calibration is also performed every time the internal temperature of the scale changes by 1°C or at 2 hour time intervals (whichever comes first).

When first plugged into the electrical wall outlet, temperature calibration will be performed regularly as the internal temperature of the scale increases to its operating level. Once the temperature stabilizes temperature calibration will be performed less frequently.

Calibration can be manually initialized by selecting the CAL RUN option from the main menu.

Function Options:

CAL Run (CAL rUn) Force automatic internal calibration to begin.

CAL Print (CAL Prn) Print Calibration Report.

1. Make sure the pan is free of any weight and stable.
2. To start calibration, press the menu key. Select “CAL ib” by pressing the T key.

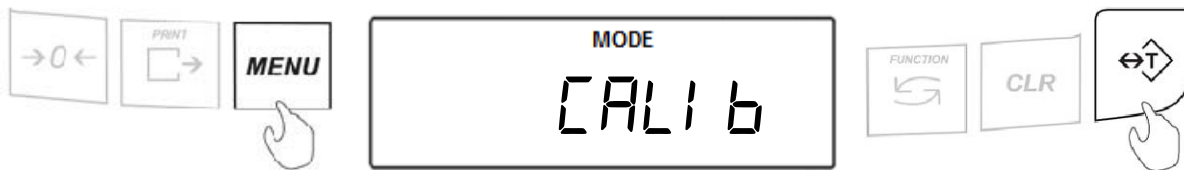

3. Select “CAL rUn” with the T key. The scale will then begin to perform calibration.

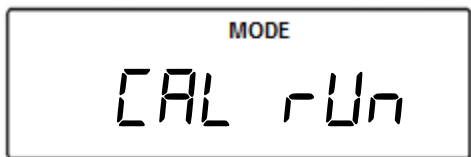

4. During calibration the scale will display “CALIB”. When calibration is finished the scale will return to weighing mode.

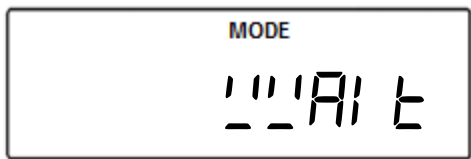

9.2 Calibration - External:

External calibration can be performed with an external calibration weight equal to the scale's capacity.

1. Enter the Weighing Mode by pressing the Function key. Select "TARE" by pressing the T key.

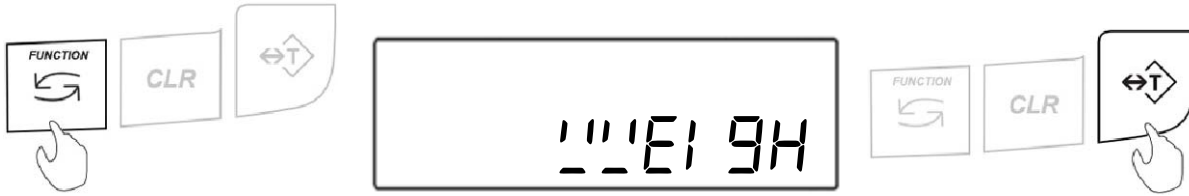

2. Use a flathead screwdriver to gently remove the Calibration Seal Screw located in the rear of the scale.

3. Once the screw has been removed and the calibration switch exposed, use a pen or another pointing device to toggle the calibration switch to the right (which is the ON position).

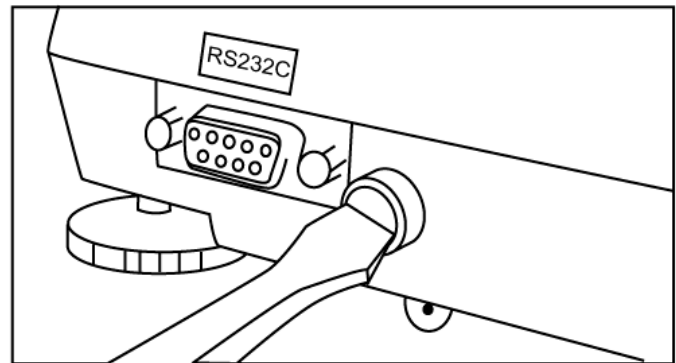

4. Upon toggling of the calibration switch, the balance will go into Calibration Mode.

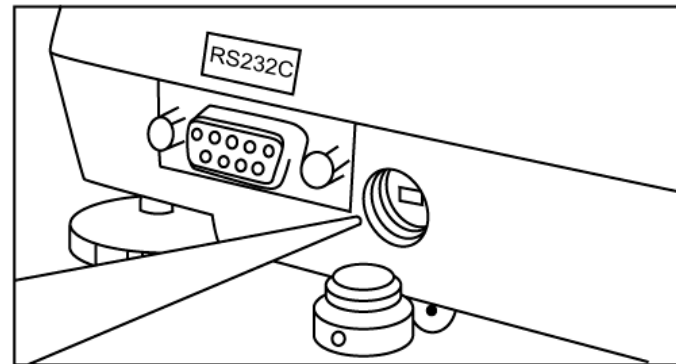
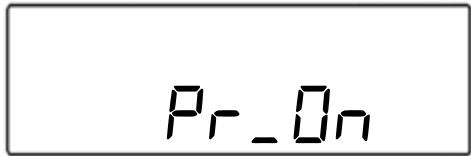

5. To start calibration, press the Menu key.

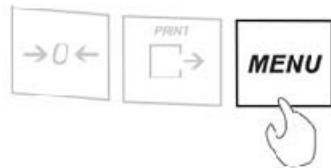

6. Select "Cal On" by pressing T key.

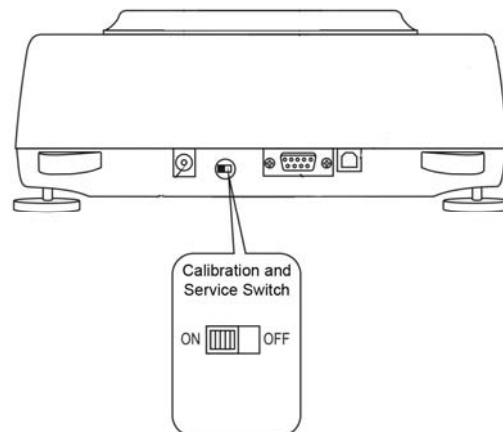
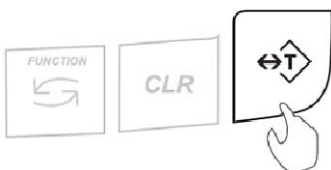

7. Wait for the scale to tare.

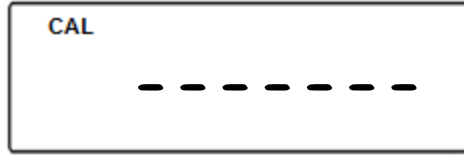
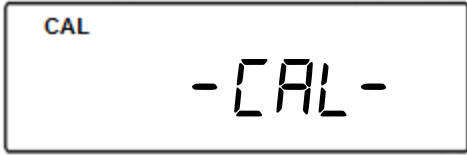

8. When prompted, load a calibration weight equal to the weight displayed on the screen. (Calibration weight varies by model).

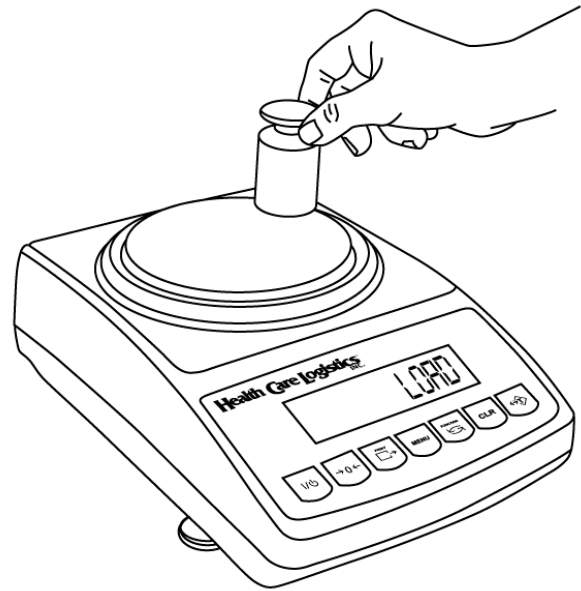

9. Wait for the scale to calibrate.

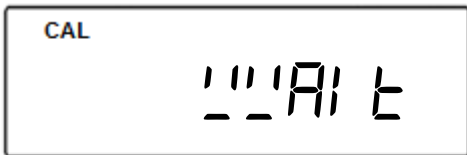

10. When calibration has ended the scale will display Pr_On. Toggle the calibration switch in the rear of the scale back to its original position.

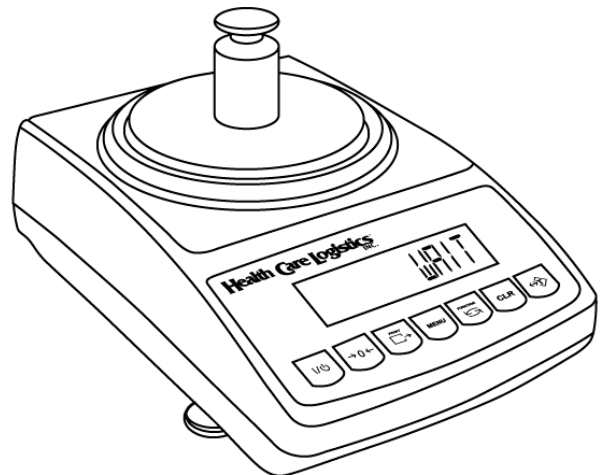
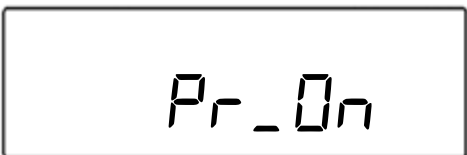

11. Insert the Calibration Seal Screw back into place.

Chapter 10: Print (Print)

A detailed transaction receipt can be printed after a count or compound has been completed. The receipt can be produced **automatically** when the transaction ends or by **manually** pressing the print key. The scale can be configured to print additional information with the transaction's results.

10.1 Print Method

1. To configure the printing setup, press the Menu key. Select "Print" by pressing the T key.

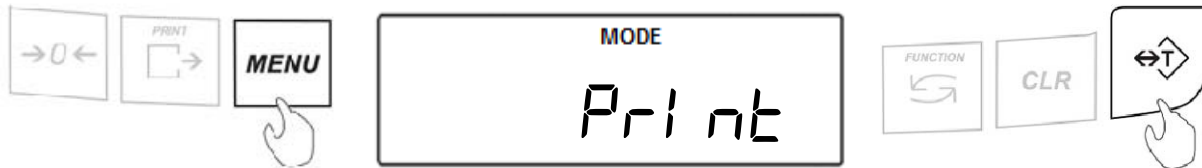

2. Choose the method of printing by selecting either "Auto" or "button" by pressing the T key.

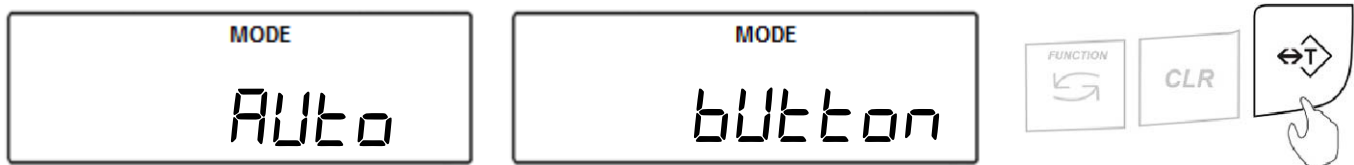

Function Options:		
Auto	(Auto)	Receipts will print automatically at the end of a transaction.
Button	(button)	Receipts will print manually when the print button is pressed.

10.2 Print Configuration

The receipt can be customized to include the following information:

	Date – Date of the performed transaction
	Time – Time at which the transaction was performed
	User Id – shows the ID number of the user which performed the weighing transaction

The receipt information can be enabled or disabled by following these steps:

1. To configure the print setup, select “Print” from the main menu by pressing the T key.

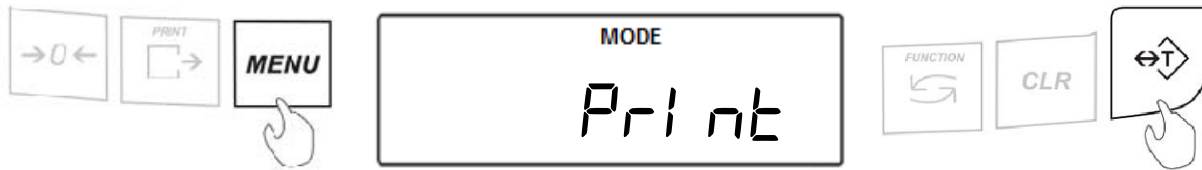

2. Select “SETUP” by pressing the T key.



3. Select a field to configure. Confirm the selection by pressing the T key.

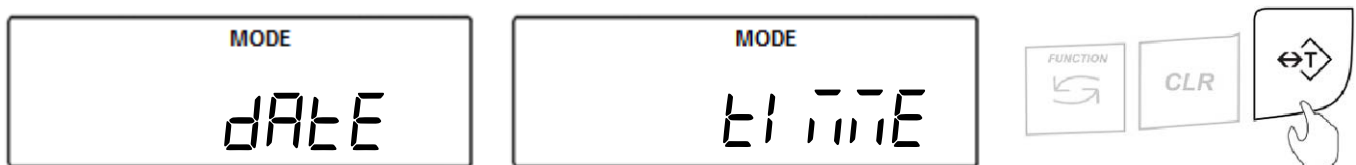

4. Choose “On” to include the field or “OFF” to exclude the field. To confirm the selection press the T key.

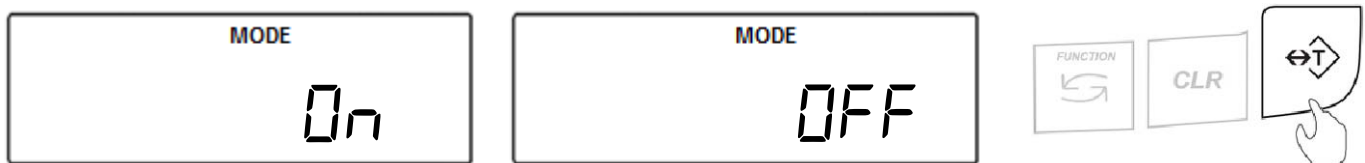

Chapter 11: Ports (Port)

After a weighing or counting transaction is completed, a result data receipt can be printed. To initiate printing, press the data transfer key. Data may be sent to a printer or a PC via the Torbal Communication Software.

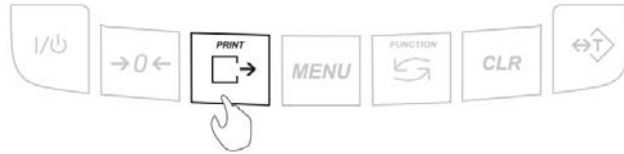

USB and RS232 Ports

The scale is equipped with both USB and RS232 interface ports. These interfaces are both configurable through the Ports menu. The USB and RS232 can be configured by their baud rate, number of bits, and parity type.

1. To configure the ports, press the Menu key. Select “Ports” by pressing the T key.

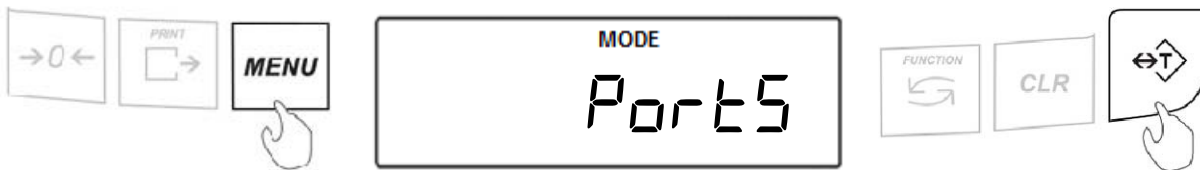

2. Choose the ports to be configured by selecting “r5232” or “U5b”. Confirm the selection by pressing the T key.

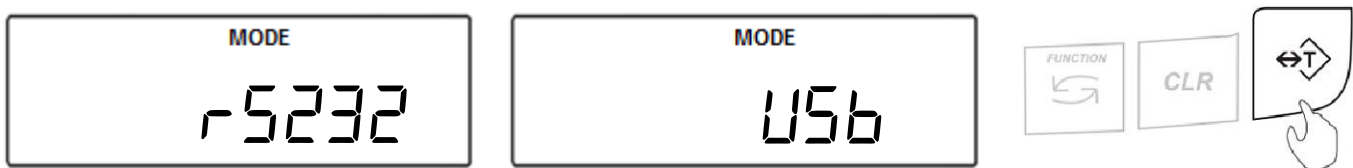

11.1 Baud Rate

3. To configure the Baud Rate select “bAUD” by pressing the T key.

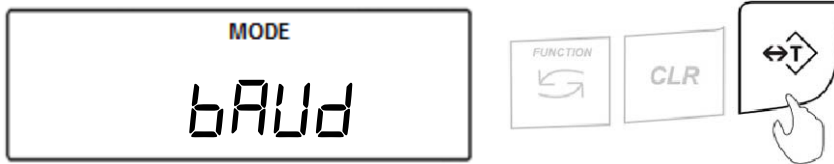

4. Choose the baud rate to be used (“1200”, “2400”, “4800”, “9600”, “19200”, “38400”, “57600”, and “115200”). To confirm the selection, press the T key.

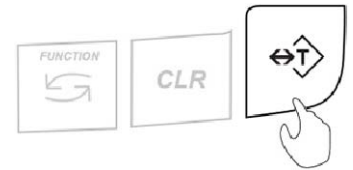

11.2 Bits

5. To configure the number of bits select “bitS” by pressing the T key.

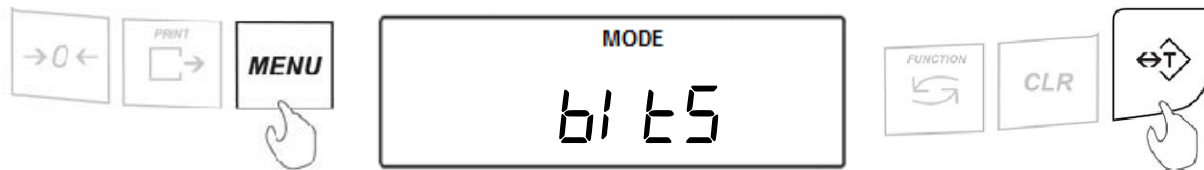

6. Choose “7 bitS” or “8 bitS”. To confirm the selection, press the T key.

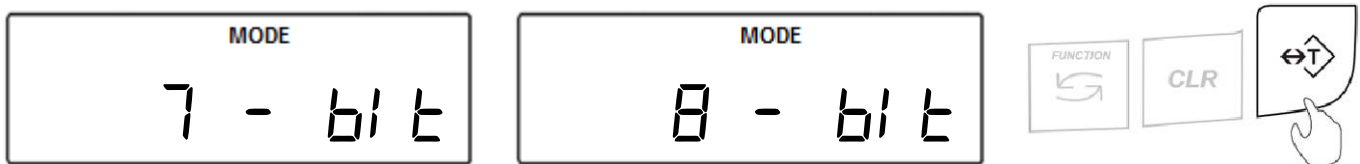

11.3 Parity

7. To configure the parity type select “PARITY” by pressing the T key.

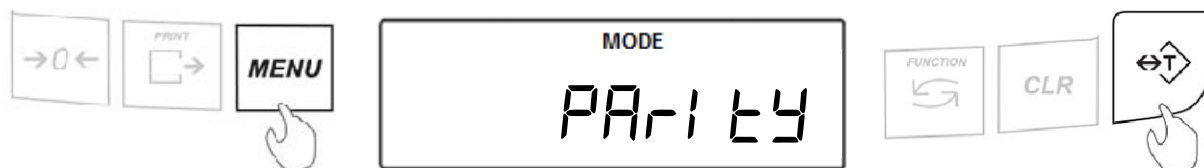

8. Choose the parity type to be used (“nonE”, “odd”, and “EuEn”). To confirm the selection, press the T key.

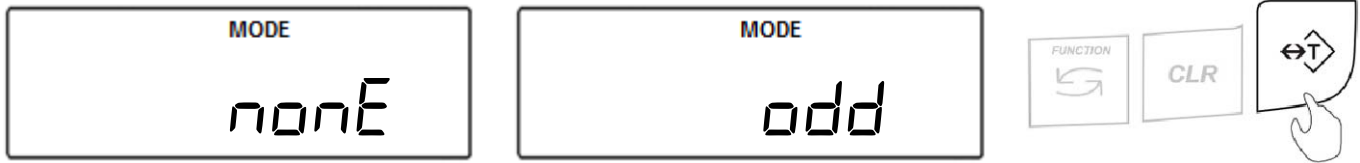

11.4 Installing Drivers

Before connecting the scale to a computer the USB Port must be configured with the appropriate baud rate and other necessary parameters. To configure the USB Port follow configuration steps from **Chapter 10** and apply them to the USB settings.

PC Connection via USB

Once the USB port has been configured, connect the scale to the PC with a Standard A/B USB cable and follow the “Found New Hardware” configuration wizard as described below.

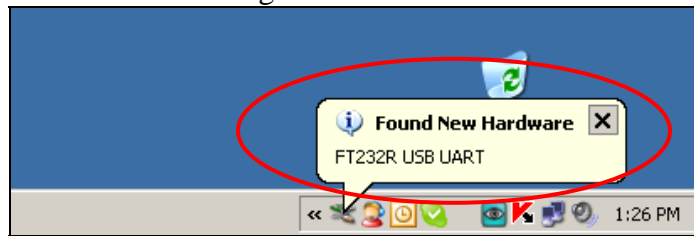

1. Allow Windows to connect to Windows Update in order to search for software. Select “Yes, this time only” and click “Next”. Once driver “FT232R USB UART” has been found, select “Install the software automatically (Recommended)” and click “Next”.

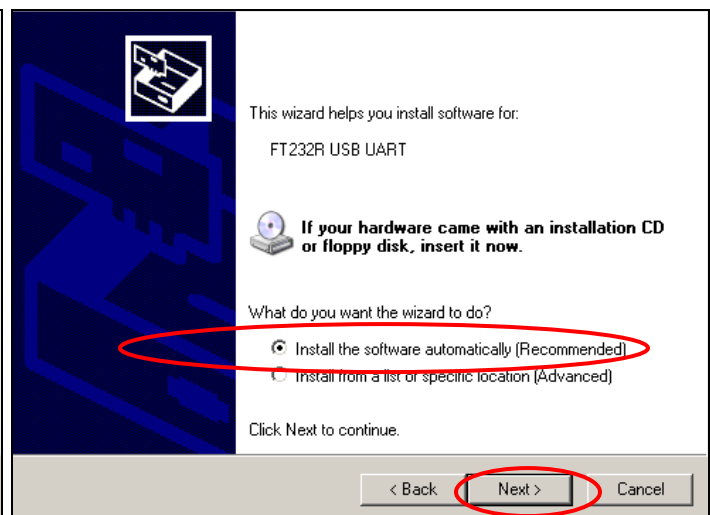
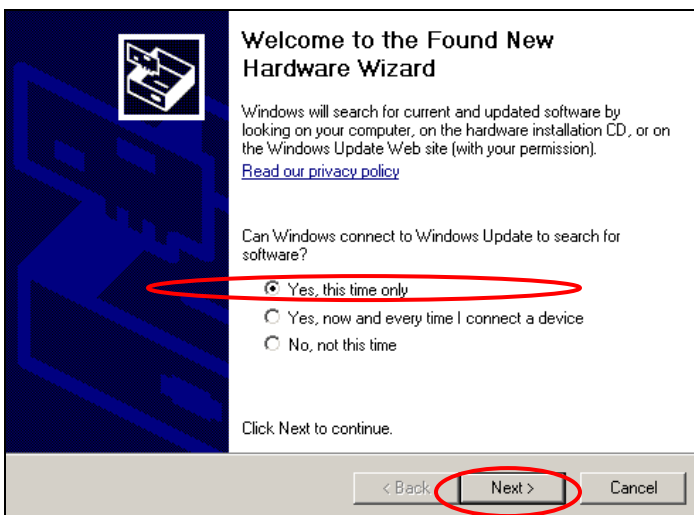

2. Windows will begin installation of the driver, when completed click “Finish”.

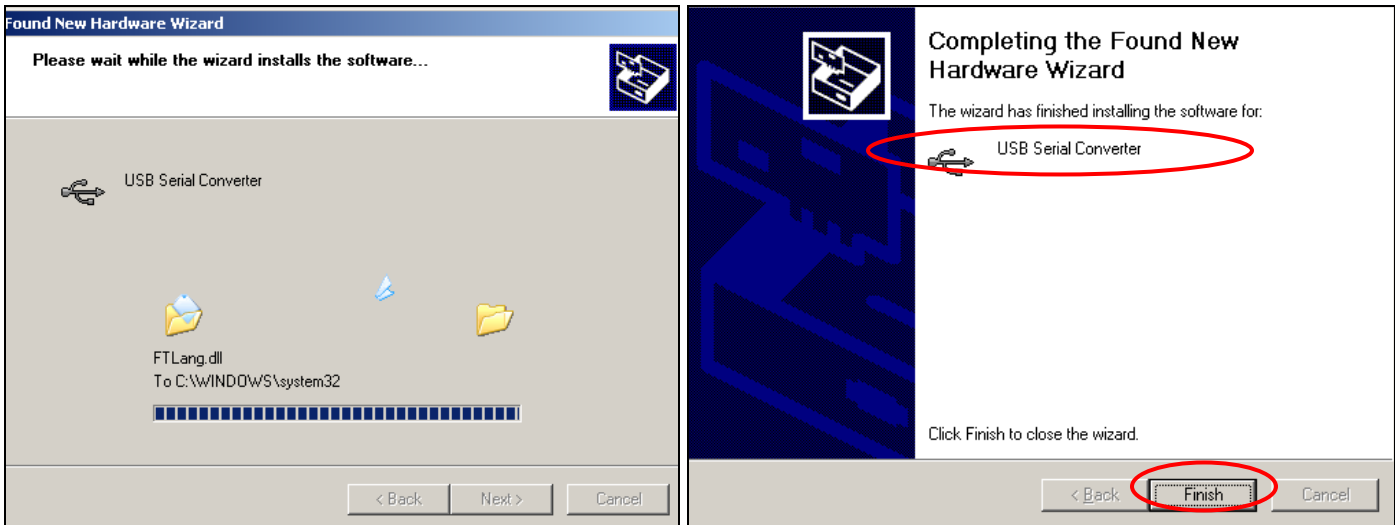

3. Once installation of the driver has been completed the scale is ready to communicate with the PC via the USB port.

11.5 Data Transmission and Exchange Protocol

Data Transmission (LONG):

Transmission Parameters: 8 bits, 1 stop bit, no parity, baud rate 4800bps,

Exchange data:

- Transmit the weight (equivalent to the Print Key, , in weighing:
 Computer→Scale: **S I CR LF** (53h 49h 0Dh 0Ah) – initiating signal,
 Scale→Computer: scale sends 16 Bytes of data as follows:

Byte	1	- The charater ‘-’ or space
Byte	2	- space
Bytes	3,4	- digit or space
Bytes	5-9	- digit, comma, or space
Byte	10	- digit
Byte	11	- space
Byte	12	- k, l, c, p or space (for kg,lb,ct,pc, or%)
Byte	13	- g, b, t, c or %
Byte	14	- space
Byte	15	- CR
Byte	16	- LF

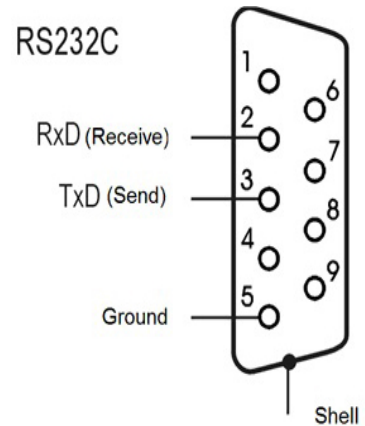

- ‘Tare the weight’ (corresponds to the →T← key in weighing):
 Computer→Scale: **S T CR LF** (53h 54h 0Dh 0Ah),
 Scale→Computer: no response.
- ‘Zero the scale’ (corresponds to the key →0← in weighing):
 Computer→Scale: **S Z CR LF** (53h 5Ah 0Dh 0Ah),
 Scale→Computer: no response.
- ‘Turn On / Off the Scale (corresponds to the key I/⏻ in weighing):
 Computer→Scale: **S S CR LF** (53h 53h 0Dh 0Ah),
 Scale→Computer: no response.
- ‘Display the MENU’ (corresponds to the key *MENU* in weighing):
 Computer→Scale: **S F CR LF** (53h 46h 0Dh 0Ah),
 Scale→Computer: no response.
- Setting the threshold 1 (optional):
 Computer→Scale: **S L D1...DN CR LF** (53h 4Ch D1...DN 0Dh 0Ah)
 where: *D1...DN* – Threshold value, up to 8 characters,
 Scale→Computer: no response,

- Example:
 To set 1000g in weight B1.5 (d=0.5g) type:
 S L 1 0 0 0 . 0 C R L F (53h 4Ch 31h 30h 30h 30h 2Eh 30h 0Dh 0Ah).
 To set 100kg in weight B150 (d=50g) type:
 S L 1 0 0 . 0 0 C R L F (53h 4Ch 31h 30h 30h 2Eh 30h 30h 0Dh 0Ah),
- Setting the threshold 2 (optional):
 Computer→Scale: **S H D1...DN** C R L F (53h 48h D1...DN 0Dh 0Ah),
 where: D1...DN – threshold value, up to 8 characters,
 Scale→Computer: no response

Cable WK-1 Configuration

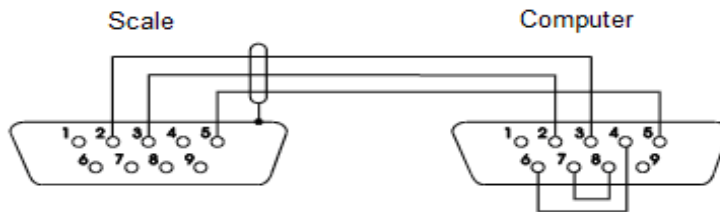

Cable WD-1 Configuration

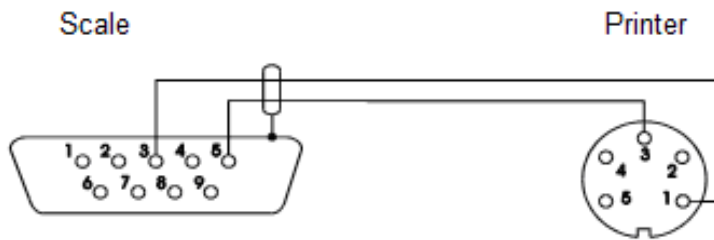

Chapter 12: Date and Time (تاریخ)

Setting the Date

1. To configure the date, press the Menu key. Select “تاریخ” by pressing the T key.

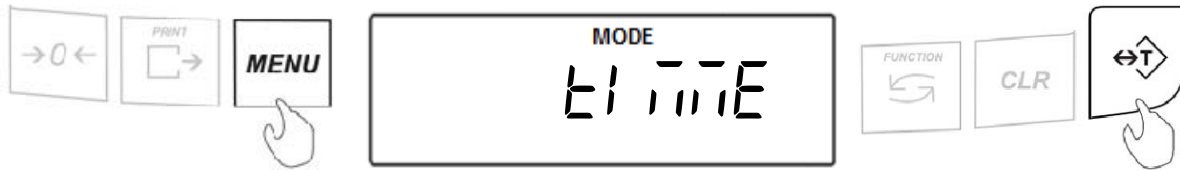

2. Select “تاریخ” by pressing the T key.

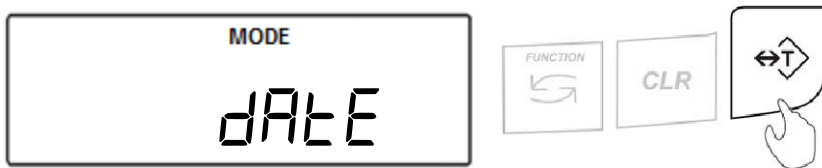

3. Press the T key to scroll between the month and then the day. Press the Function key to increment a digit.

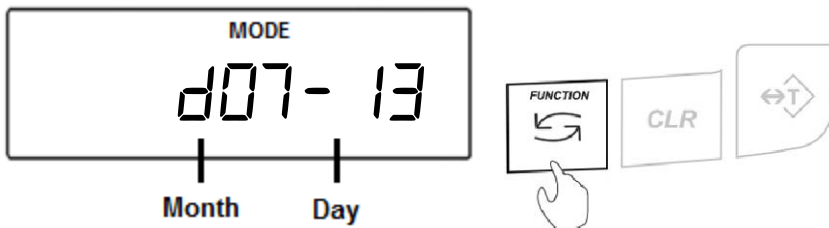

4. Once the day and month are confirmed the screen will switch to the year. Press the T key to scroll between the digits and press the Function key to increment a digit.

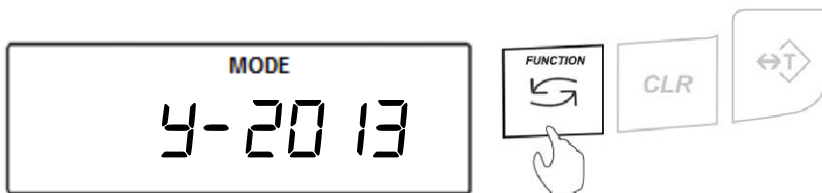

5. Once the date is confirmed the scale will automatically exit the menu.

Setting the Time

1. To configure the date, press the Menu key. Select “E/ M̄E” by pressing the T key.

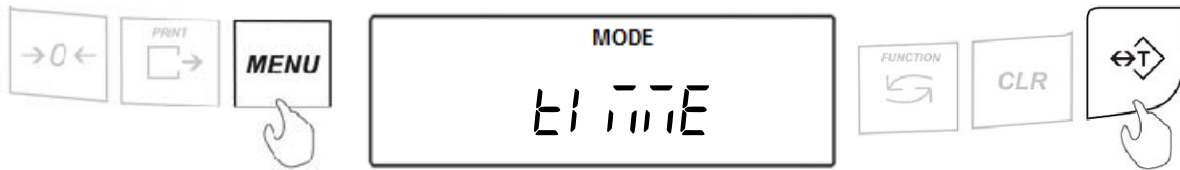

2. Select “E M̄E” by pressing the T key.



3. Press the T key to scroll between the minutes and then the hours. Press the Function key to increment a digit.

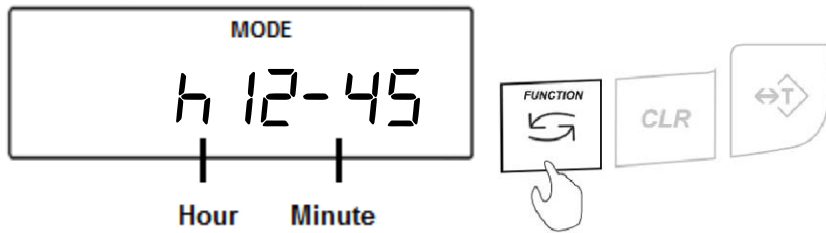

4. Once the minutes and hours are confirmed the screen will switch automatically to the time of day selection. Select “A M̄” or “P M̄” by pressing the T key.

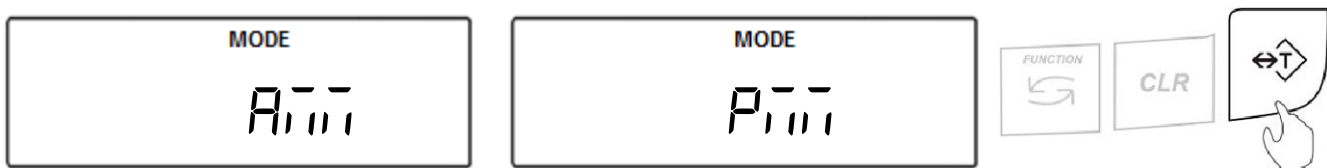

Chapter 13: Sound (Sound)

The keypad sound can be turned on or off from the Sound menu. When set to “On” the scale sounds a buzzer whenever a button is pressed on the keypad.

1. To configure the sound, press the Menu key. Select “Sound” by pressing the T key.

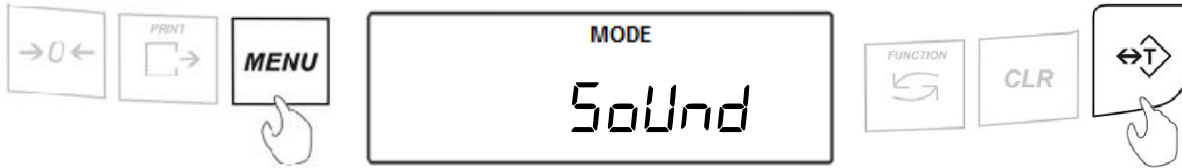

2. Select “On” to enable the sound or “OFF” to disable the sound. To confirm the selection press the T key.

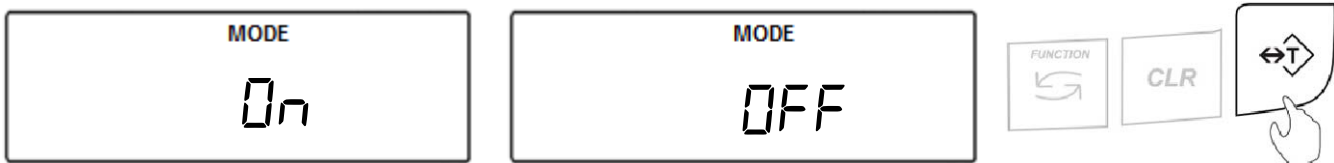

Chapter 14: Firmware (Firmware)

To update the scale’s firmware, the scale must be connected to a PC. A firmware update must be enabled simultaneously through Torbal Utility software on the PC as well as the Firmware option on the scale itself.

Note: The firmware update process should be started using the firmware update option on the scale first and then continued immediately after using the firmware update on the PC.

Follow these steps to update the scales firmware:

1. To update the firmware, press the Menu key. Select “Firmware” by pressing the T key.

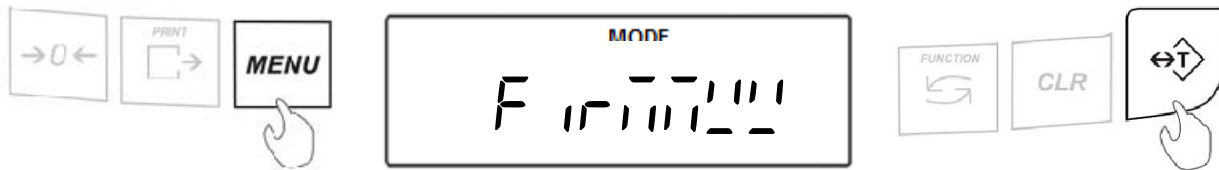

2. Select “Start” by pressing the T key.

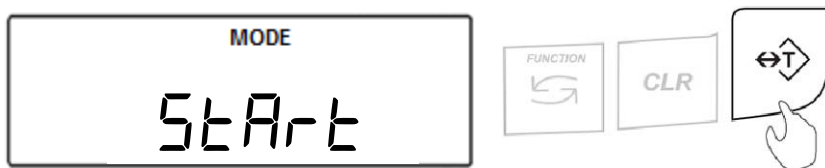

Chapter 15: Restoring Default Settings (dEFAULT)

The scale can be restored to its factory settings. This process will return the scale to its original configuration.

Note: All saved data/settings in the scale will be lost when defaults are restored.

Follow these steps to restore default settings:

1. To restore default settings, press the Menu key. Select “dEFAULT” by pressing the T key.

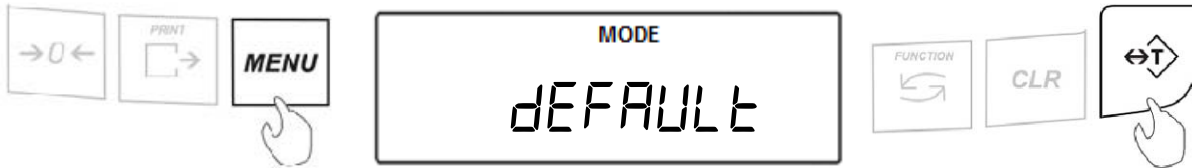

2. Select “YES” to restore the default settings or “nO” to continue with the current configuration. Confirm the selection by pressing the T key.

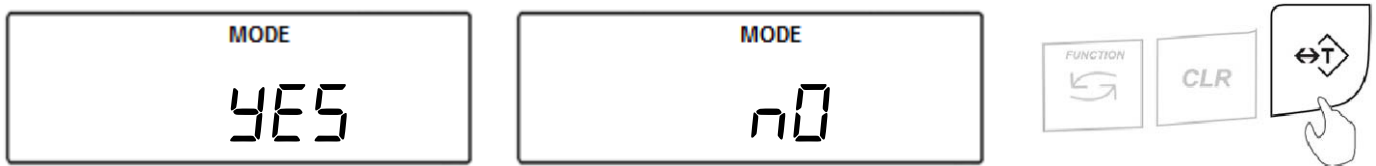

Chapter 16: Weighing

1. To enter Weighing Mode, press the Function key. Select “TARE” by pressing the T key.

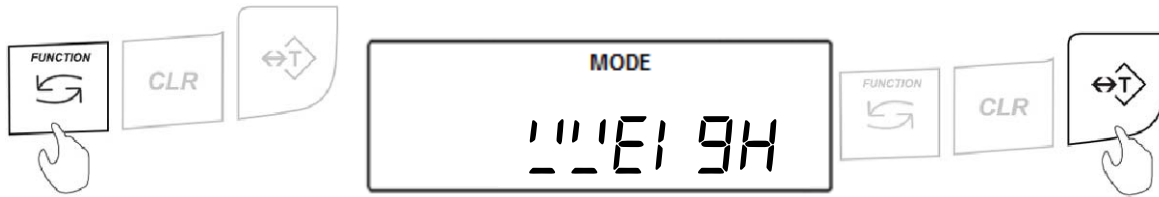

2. Wait for the stabilization indicator to appear.



3. When weighing, always place the mass in the middle of the pan. The weighed result may be taken when the stabilization indicator reappears on the display.

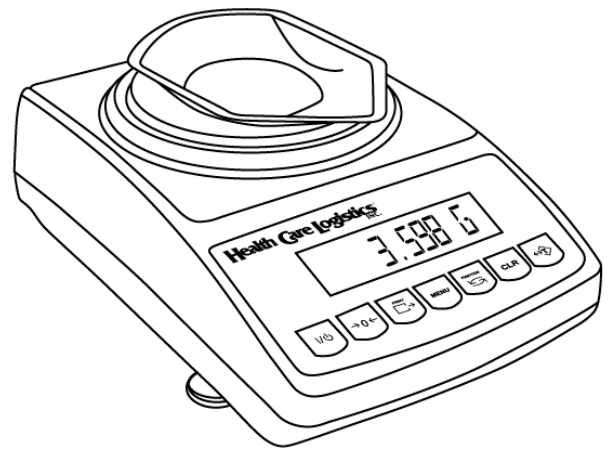

16.1 Zeroing the Scale

1. The scale is armed with the Auto Zero Setting Mechanism (AZSM). AZSM automatically maintains a center of zero condition within +/- .5d or 5mg.
2. The scale may be re-zeroed manually to obtain a new center of zero. To re-zero the scale manually with a weight that is out of the AZSM range, make sure the weight and the stabilization indicator are shown on the display.
3. Re-zero the scale by pressing the zeroing key.



- When finished re-zeroing, the scale will return to Weighing Mode and the display will indicate “0”. A new center of zero has been set, and the scale is ready for weighing.



Note: Re-zeroing the scale will reduce the capacity of the scale by the re-zeroed weight. The remaining capacity is displayed as a percentage on the right side of the display.

16.2 Taring the Scale

- If a container is used for weighing, it may be tared. In taring the container, the scale subtracts the weight of the container from the gross weight to obtain the net weight.
- To tare the weighing container, place it in the middle of the pan. The container’s weight will be shown on the display.



- Once the stabilization indicator appears on the display, the container is ready to be tared. To tare the container, press the T button. The display will show a dotted line indicating that the scale has begun the taring process.

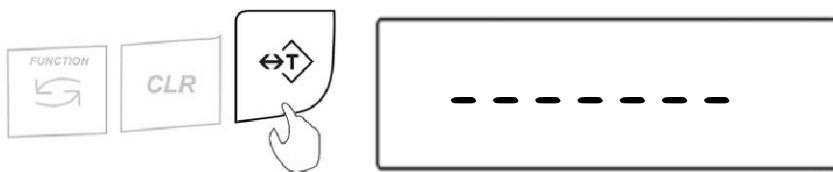

- When finished taring, the balance will return to Weighing Mode. The display will indicate “0”, and the NET indicator will be shown on the display signaling the next weight taken is a NET result.



Note: Do not touch or move the scale during the taring process.

16.3 Clearing the Tare

1. To clear the tare, remove the tared object along with the NET weight from the pan. The scale will then display a negative NET tare result.



2. To clear the tare, press the T button. The display will show dotted lines, indicating the tare is clearing.

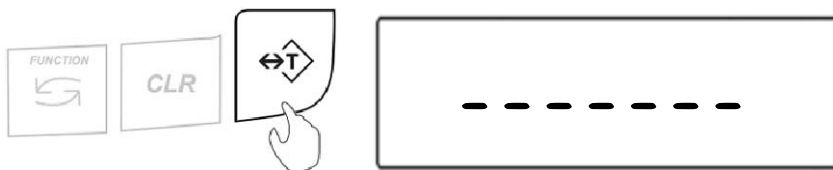

3. When finished clearing the tare, the scale will return to Weighing Mode.



Chapter 17: Pill Counting

1. To enter Pill Counting Mode, press the Function key. Select “Count” by pressing the T key.

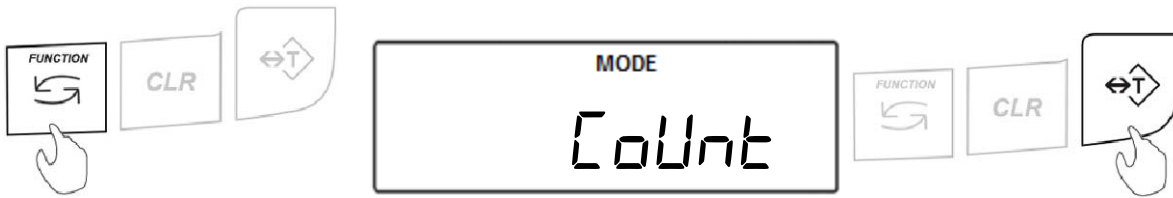

2. “PrESS tArE” will appear on the scale’s display, indicating to tare a counting container.

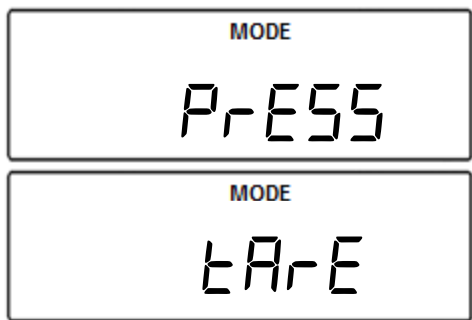

3. Place an empty vial or counting container on the pan. The container’s weight will be displayed. Wait for the weight to stabilize and press the T key to tare.

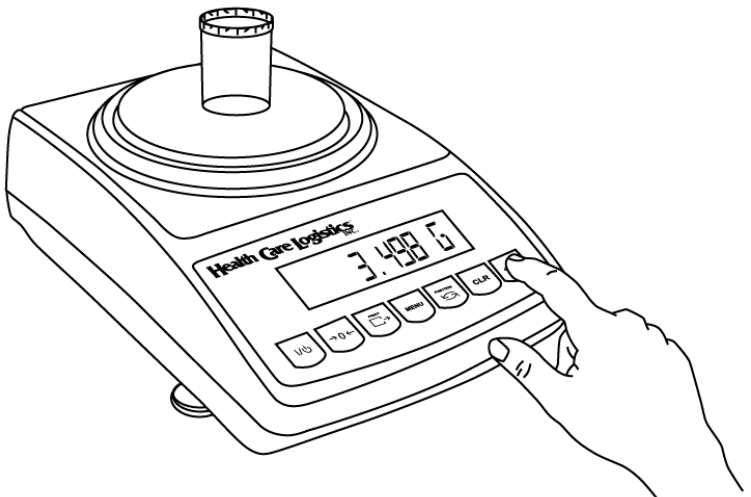
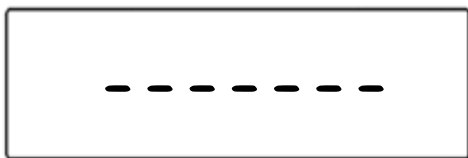
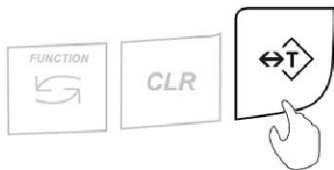
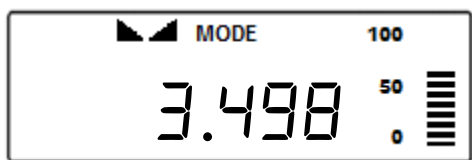

- The scale will display SAPL ON (SAPL 0n). Manually count the required piece sample and place it in the container on the pan.

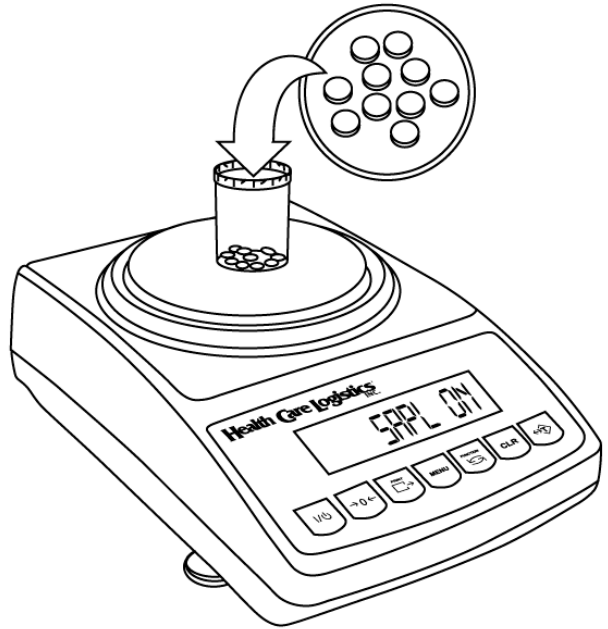
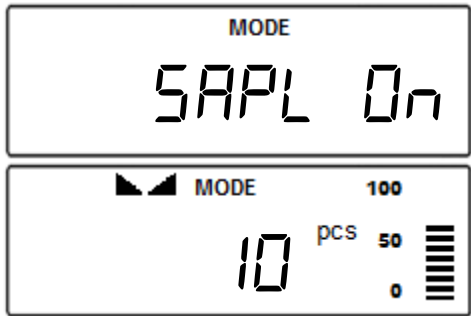

- The scale will display the weight of the sample. Press the T key to confirm the sample weight.

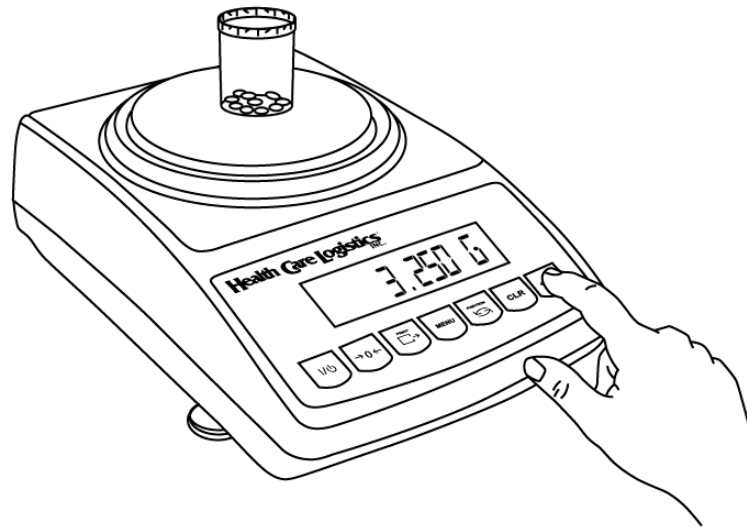
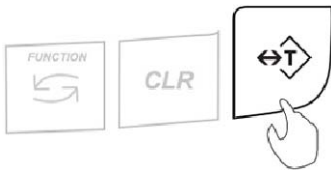

- The scale will display FILL indicating to begin filling the remainder of the count. Begin to pour the pills into the container.

- Once an accurate piece count has been taken, the container and its contents may be removed from the scale. After removing the container, *done* will appear on the screen.

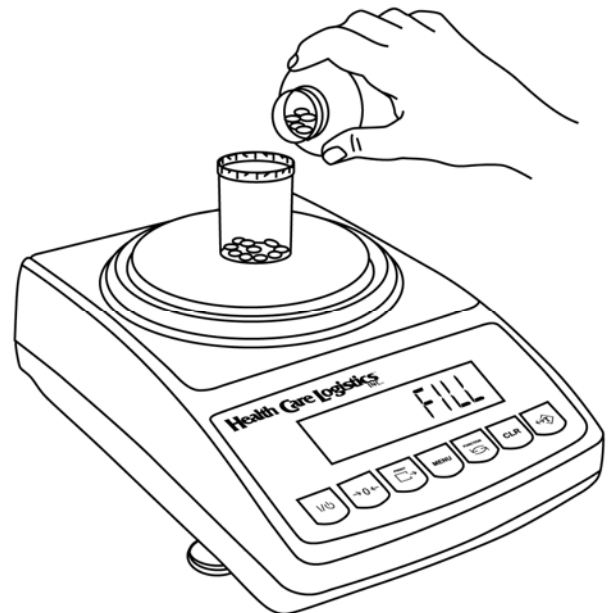

Note: If more pieces have been placed into the container than actually desired, you may use tweezers, a pharmacy spoon, or a similar instrument to remove the container from the pan, dispense out the excess pieces, and place it back on the pan to recheck the count

- To finish the count and begin a new one, press the Clear key.

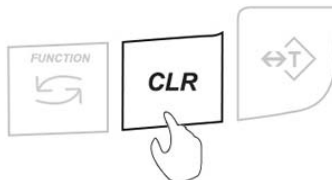

Chapter 18: Advanced Pill Counting Accuracy (APA)

When enabled APA will correct for possible average pill weight variations that may exist. To use the APA feature follow the steps below.

1. Follow all steps required to perform a pill counting transaction (Chapter 16, steps 1 through 5).

Once the “FILL” command is displayed, slowly begin to count the pills. In order to activate APA stop the count between **10** and **15** pieces. When a count in the range of 10 to 15 pieces is reached, stop and wait for the scale to stabilize the result. Once the result is stable the scale will calculate a new average piece weight. The scale will sound a buzzer and an “OK” will flash in the upper left corner of the display. After APA is activated at the first stop, an APA indicator (A) will appear at the bottom left of the display. A new average pill weight has been calculated based upon the weight of the pills in the vial and the count may be continued.

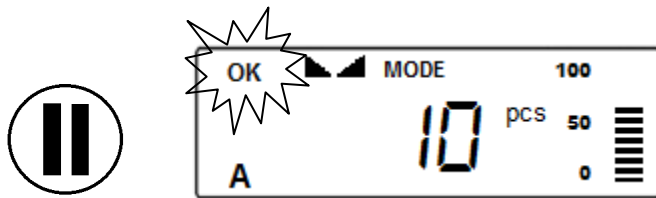

Note: Stopping outside this range will not activate the APA feature.

2. For an even greater accuracy, APA can be activated once again when stopping the count between 20 and 30 pieces. Activating APA in this range can be particularly useful when counting large quantities.

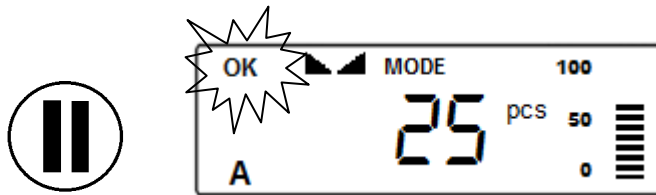

Note: If APA was not performed or activated at the 10 to 15 range it will not activate at the 20 to 30 range.

3. For an even greater accuracy, APA can be activated once again when stopping the count between 50 and 70 pieces. Activating APA in this range can be particularly useful when counting large quantities.

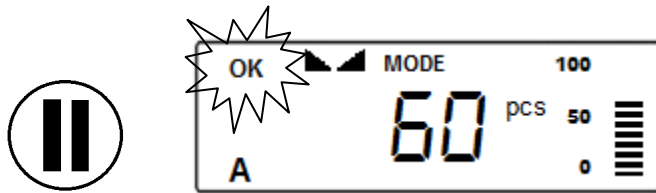

Note: If APA was not performed or activated at the 10 to 15 range and 20 to 30 range it will not activate at the 50 to 70 range.

Chapter 19: Pill Fragment Detection (PFD)

When enabled the feature allows to check for possible pill fragments or broken pills when performing a count. The feature signals a warning by displaying a PFD indicator (F) on the display whenever a fragment is detected that is smaller than 40% or larger than 60% of the counted pill weight. You must enable APA in order to use Pill Fragment Detection. PFD is activated only at the 2nd and 3rd APA range. PFD will not activate between 1 and 15 pills.

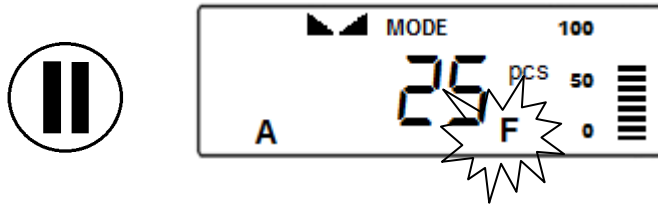

1. Follow all steps required to perform a pill counting transaction.

2. Once command “FILL” is displayed begin to count the pills. In order to check for a possible Pill Fragment during the 2nd and 3rd stop you must stop the count between 10 and 15 pieces to activate APA.

3. When you reach a count of 10 to 15 pieces stop and wait for the scale to stabilize.

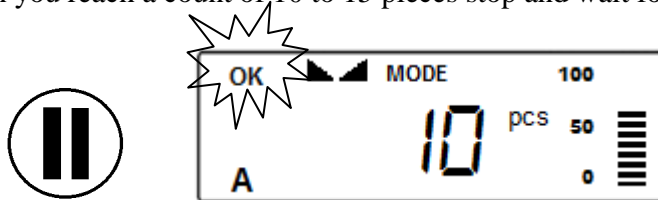

Note: Stopping outside this range will not activate the APA feature.

4. Once the scale is stable it will calculate a new average piece weight and perform APA.

5. Continue counting and pause the count between 20 and 30 pills. PFD will be now be activated to check for possible pill fragments.

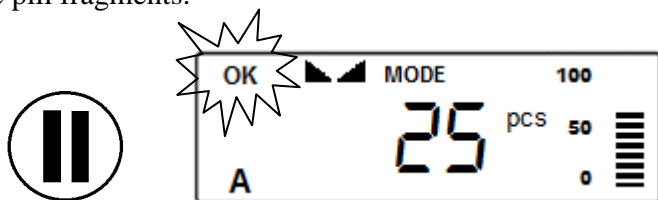

6. Continue counting and pause at all remaining APA ranges to activate PFD.

Chapter 20: Compounding

1. To enter Compounding Mode, press the Function key. Select “COMP” by pressing the T key.

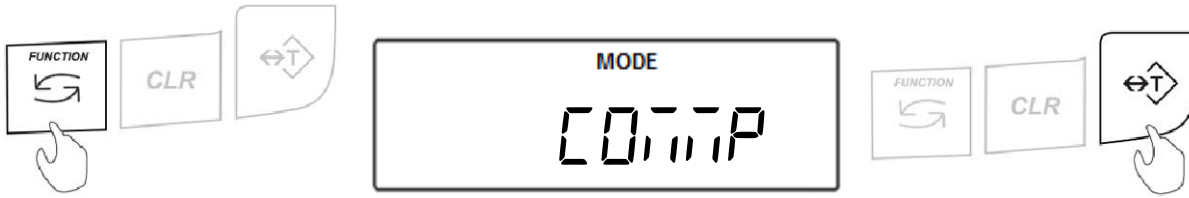

2. “PRESS TARE” will appear on the scale’s display, indicating to tare a container.

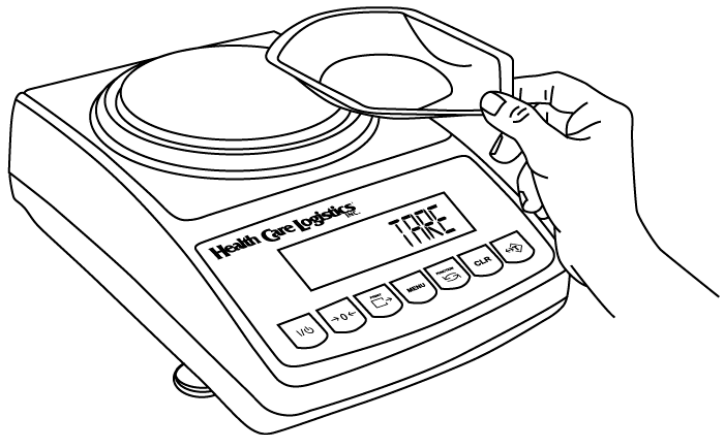
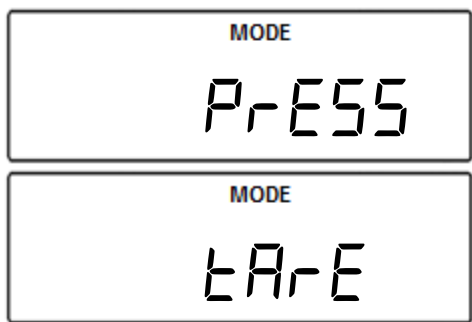

3. Place an empty container on the pan. The container’s weight will be displayed.

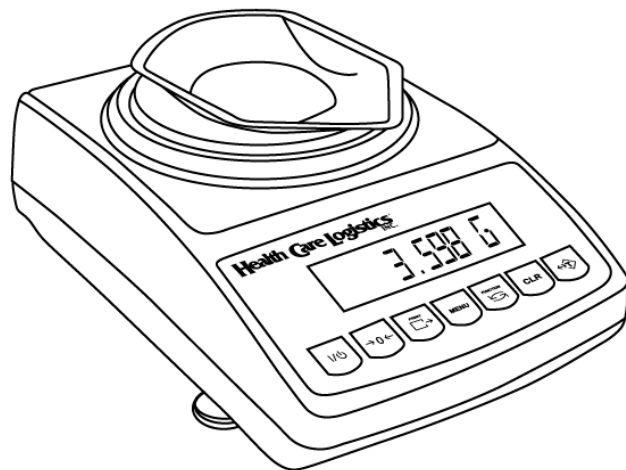
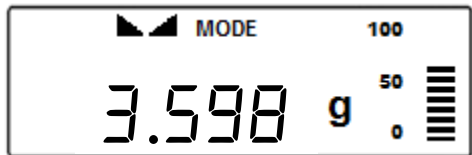

4. Wait for the weight to stabilize and press the T key to tare.

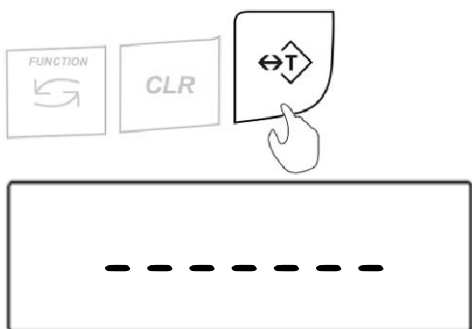

- After the container is tared, “1.79 01” will appear on the display, indicating the scale is ready for the first ingredient.

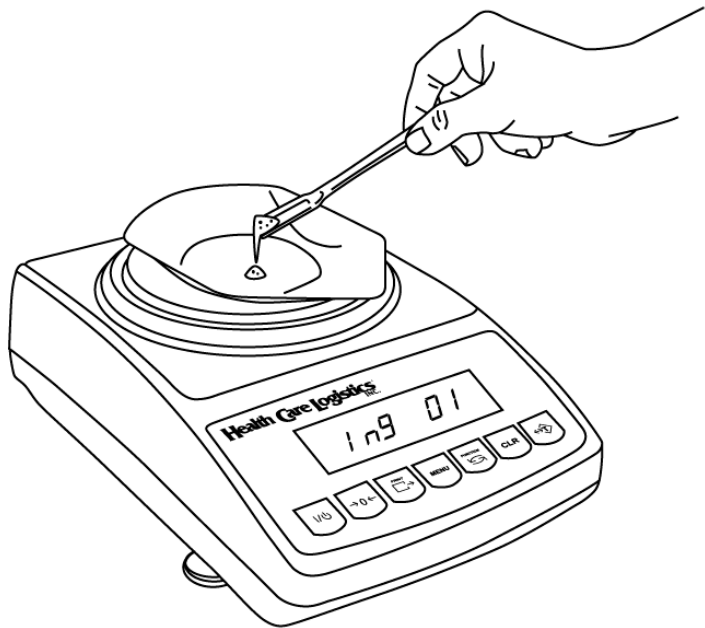
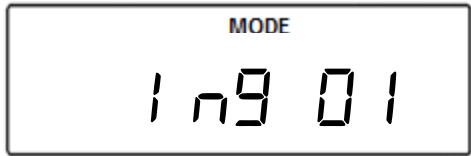

- Add the ingredient until the desired weight is displayed and the stability indicator appears on the display.



- Once a desired weight is displayed press the T key to store the ingredient in the scale's memory.

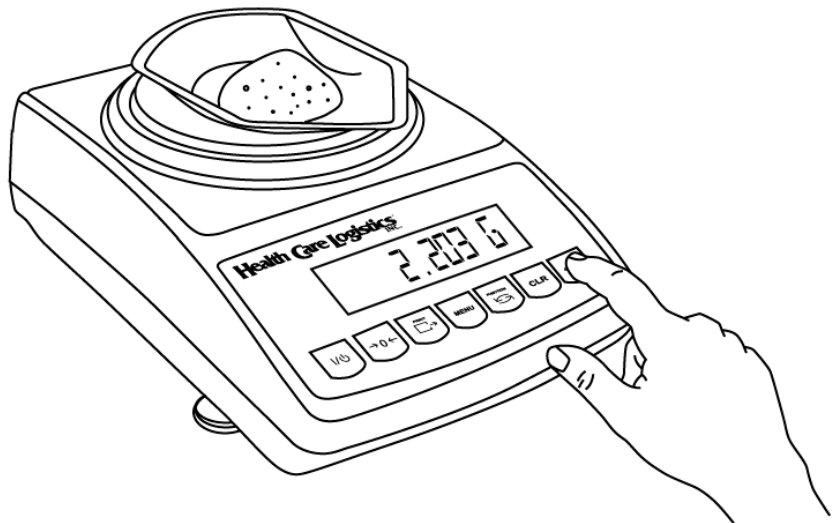
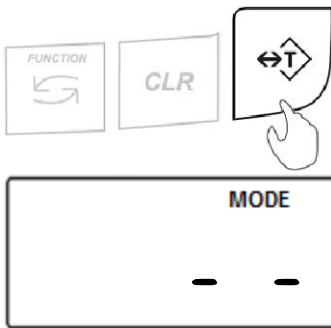

- Once the weight is stored, the scale will display “PRESS TARE” indicating to tare a container for the second ingredient. You may now repeat steps 3 to 7 to add more ingredients to the recipe.

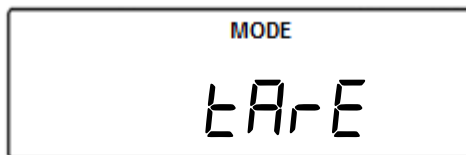
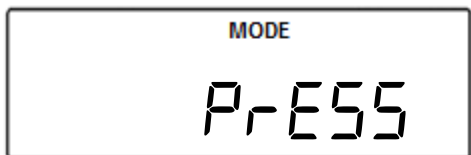

9. To obtain the total press the CLR key. To continue adding more ingredients press the T key while the total is displayed. To reset the compounding function and start a new recipe press the CLR key again while the total is displayed.

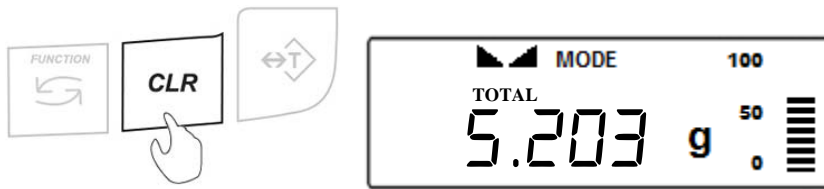

10. To print the recipe, press the Print key.

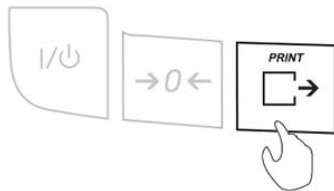

Chapter 21: Sealing the Calibration Switch

Depending on individual state law, the calibration feature of the scale may be required to be sealed by an NIST/NTEP official. To seal the calibration feature, follow the instructions below. The scale can be sealed in two ways by using either a paper seal or a wire seal.

Paper Seal:

1. To seal the scale using a paper seal or a sticker, use a flathead screwdriver to gently remove the calibration wire seal screw located in the rear of the scale.
2. Once the wire seal screw has been removed and the calibration switch exposed, gently insert the flush sealing screw provided with the scale in the place of the wire seal screw.

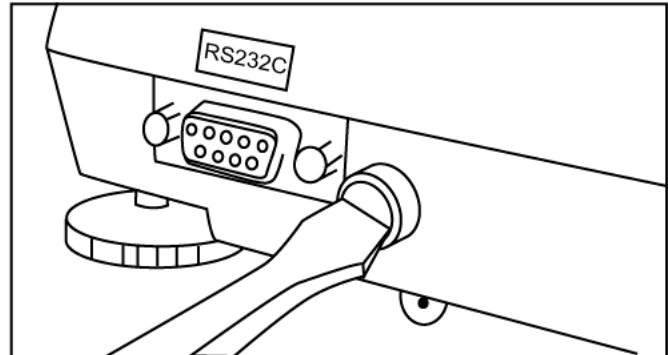

Warning: Do not attempt to screw the flush sealing screw all the way in. Stop when the screw is flush with the casing of the scale.

3. Once the flush sealing screw is in place, apply the paper seal over it, so that it completely covers the flush screw.

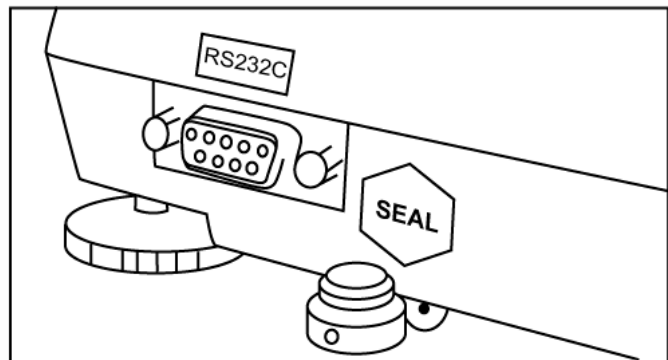

Wire Seal:

1. To seal the scale using a wire seal, insert the wire into the opening of the calibration wire seal screw.
2. Insert one end of the wire through the opening in the fixed rear foot located underneath the scale.
3. Bring both ends of the wires together and close the wire loop with a seal. Do not attempt to remove the calibration screw as it will rip the wire and break the seal.

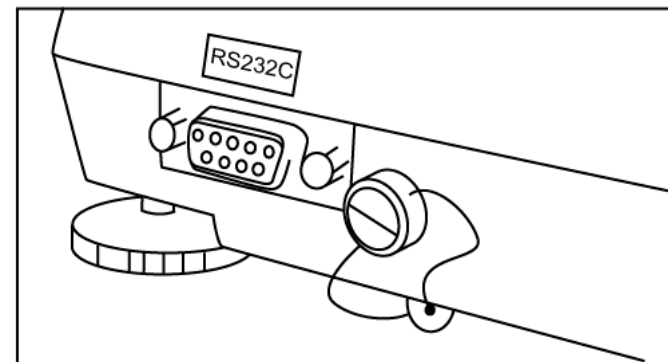

Chapter 22: Maintenance

Cleaning and maintaining your Prescription Scale:

- Before cleaning the scale always unplug the A/C adapter from the electrical outlet.
- Use a soft, slightly damp cloth to clean the exterior housing of your scale.
- Wipe the scale gently. Do not allow any liquid to enter into the scale.
- Do not apply extensive pressure to the LCD display.
- Do not use chemicals or benzene when cleaning the surface. Corrosive chemicals may damage the finish.
- Alcohol may be used only to clean the scale's stainless steel pan or the draft ring.

Chapter 23: Accessories

Description	Part No.
Draft Shield Cover	301086
Dust Cover	301056
RXP-4 Thermal Printer	301060
RS232 PC Cable	301058

Chapter 24: Replacement Parts

Description	Part No.
A/C Adaptor	301054
Pan (115mm)	501094
Pan Base	501095
RS232 Printer Cable	-
Scanner w/ Cable	301050

Chapter 25: Limited Warranty

PURCHASER'S 12-MONTH WARRANTY

Warranty is valid only if the attached warranty registration card is completed and returned within 30 days.

This product is a precision device made to exacting standards of scientific accuracy. It is guaranteed to have been adjusted and inspected for proper workmanship and performance, and certified for its currently advertised specifications before shipment.

Fulcrum Products are warranted against defects in material and workmanship under normal use and service. This warranty is extended only to the first purchaser. This limited warranty will not apply if, upon inspection, it is found that the product was tampered with, misused, overloaded, or abused. mishandled, placed in an improper environment, improperly installed or adjusted, used for a purpose other than that for which it was designed, or repaired by unauthorized personnel.

Fulcrum's liability under this warranty is limited to furnishing labor and parts necessary to remedy the defect covered by this warranty and restore the product to normal operating condition. Purchasers may be charged a minimum repair fee for in-warranty products returned for repair if those products are determined to be problemfree. To make a claim under this limited warranty, obtain an RMA number from Fulcrum and return the product, carefully packed in its original packaging, shipping prepaid, with the RMA number written on the return package.



Call Free: 1.800.848.1633 • Fax Free: 1.800.447.2923
GoHCL.com • hcl@GoHCL.com